

DATE  
MAY 3, 2004  
CATALOG NO.  
XV0106C

OUTLINE DIMENSIONS  
3-PHASE INDUCTION MOTOR

MOTOR TYPE:  
AEUHXF  
FRAME NO. 256TC

Pole	HP	KW	Hz	VOLT	Syn. Speed RPM
6	10	7.5	60	230/460	1200

Ins	Rating	Dimension in	Approx Weight	Bearings	
F	CONT.	inches	407 lbs.	DE: 6309ZZ	NDE: 6307ZZ

Totally Enclosed Fan-Cooled Type, Squirrel-Cage Rotor.

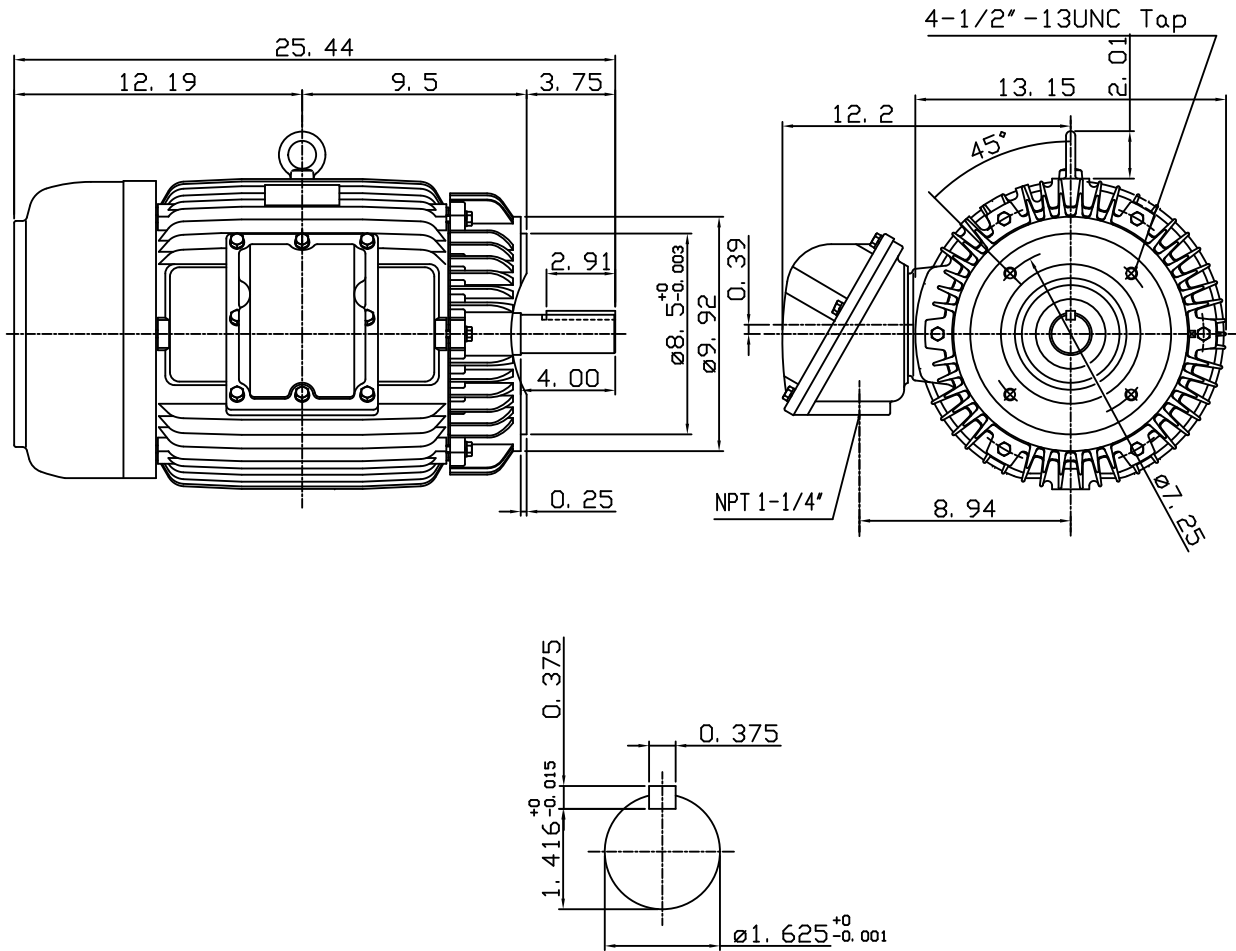

NOTE:

- EXPLOSION PROOF:  
CLASS I GROUP D AND  
CLASS II GROUP E, F, G.



DWN.	J. H. LIANG	12-04-98
CHKD.	C. S. LO	12-10-98
APPD.	Y. B. HUANG	12-10-98

TECO Westinghouse

DWG NO.  
31049U556000