

DATE  
Sept. 25, 2006  
Cat. #: EP0254C

OUTLINE DIMENSIONS  
3-PHASE INDUCTION MOTOR

MOTOR TYPE:  
AEHH8N-CF  
FRAME NO. 284TC

Pole	HP	kW	Hz	VOLT	Syn. Speed r/min(rpm)
4	25	18.7	60	230/560	1800

Ins	Rating	Dimension in	Approx Weight	Bearings
F	CONT.	inches	441 lbs	DE: 6311ZZ NDE: 6310ZZ

Totally Enclosed Fan Cooled Type. Squirrel-cage Rotor.

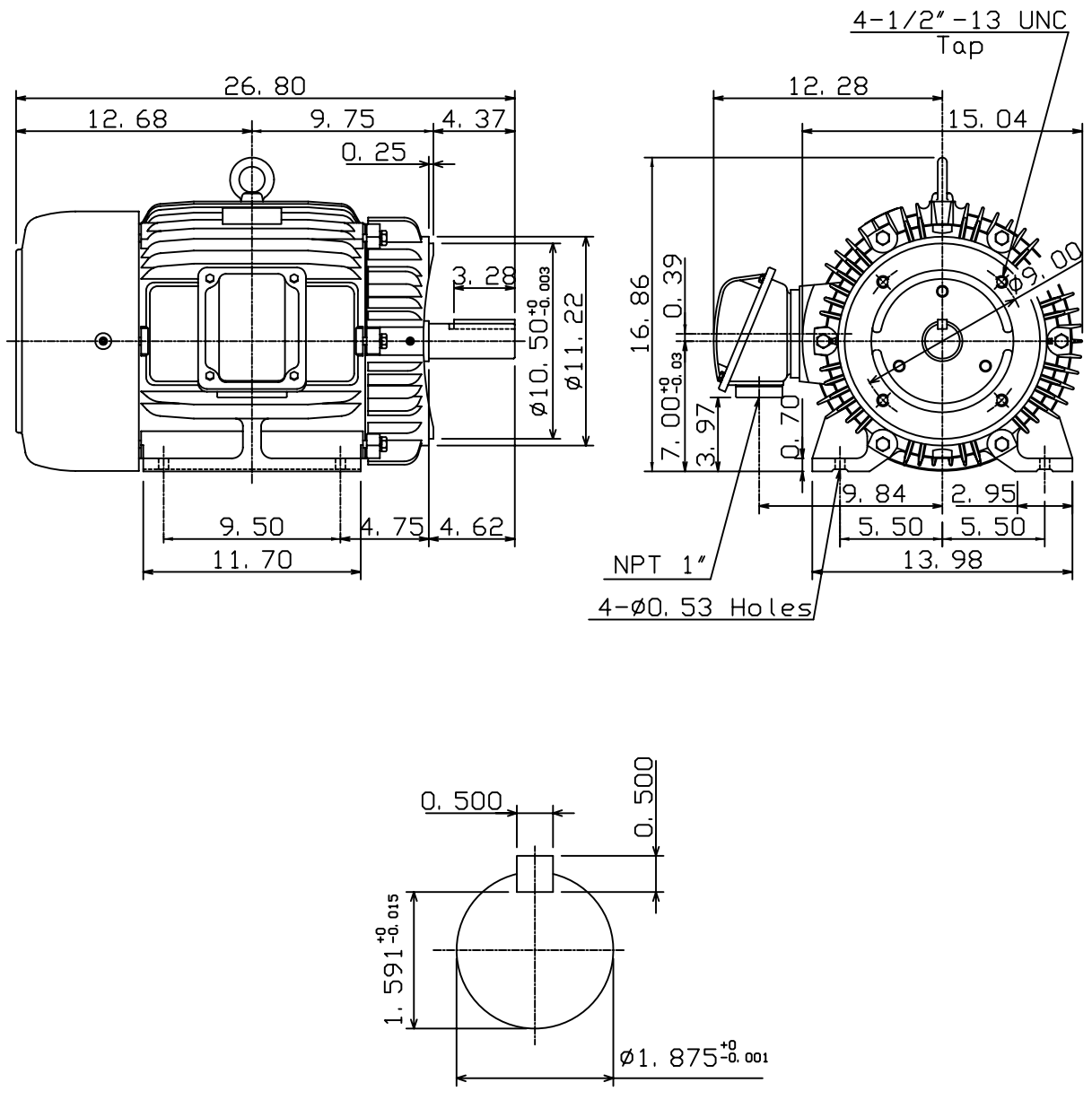

① 01. 10. 05 K. L. KUO

DWN.	K. L. KUO	11-03-04
CHKD.	C. H. KAO	11-04-04
APPD.	M. C. TSAI	11-04-04



DWG NO.  
31049J814111