

THIS IS AN UPDATED REVISION, THE PREVIOUS ONE MUST BE DISREGARDED.

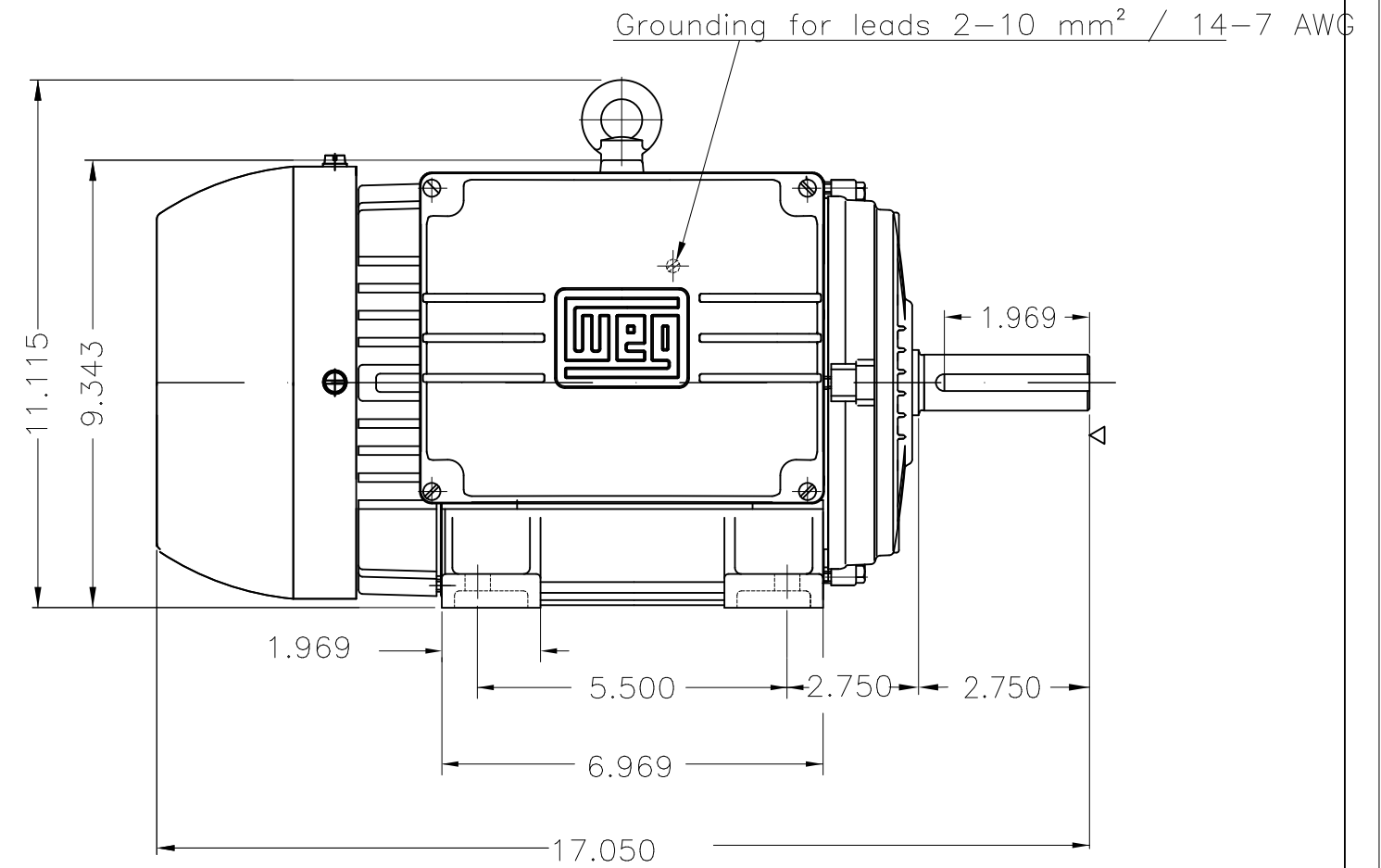
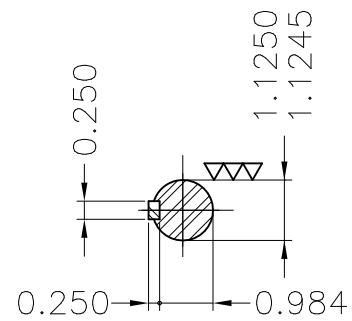
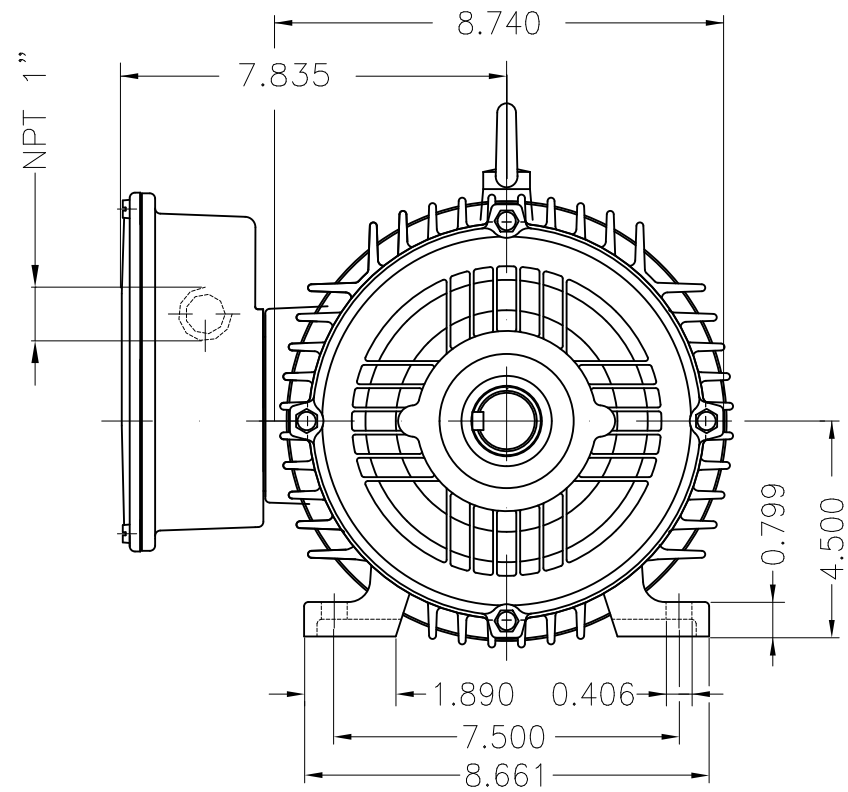
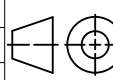

Mounting B3R(D)

ECM	LOC	SUMMARY OF MODIFICATIONS	EXECUTED	CHECKED	RELEASED	DATE	VER
EXECUTED	USERADMIN	 SINGLE PHASE MOTOR FRAME 184T IP55 TEFC WEG code: 10679138					
CHECKED							
RELEASED							
REL DT	24.07.2017	WMO Jaragua do Sul	Product Engineering	SHEET	1 / 1		

3 HP 04 Poles 60Hz

A

