

**Dimensional Drawing**

Catalogue	Model	HP	Pole	kW	Rating	Voltage	Hz	RPM
APH0152	AEHH8R	15	2	11	Continuous	460 V	60	3600

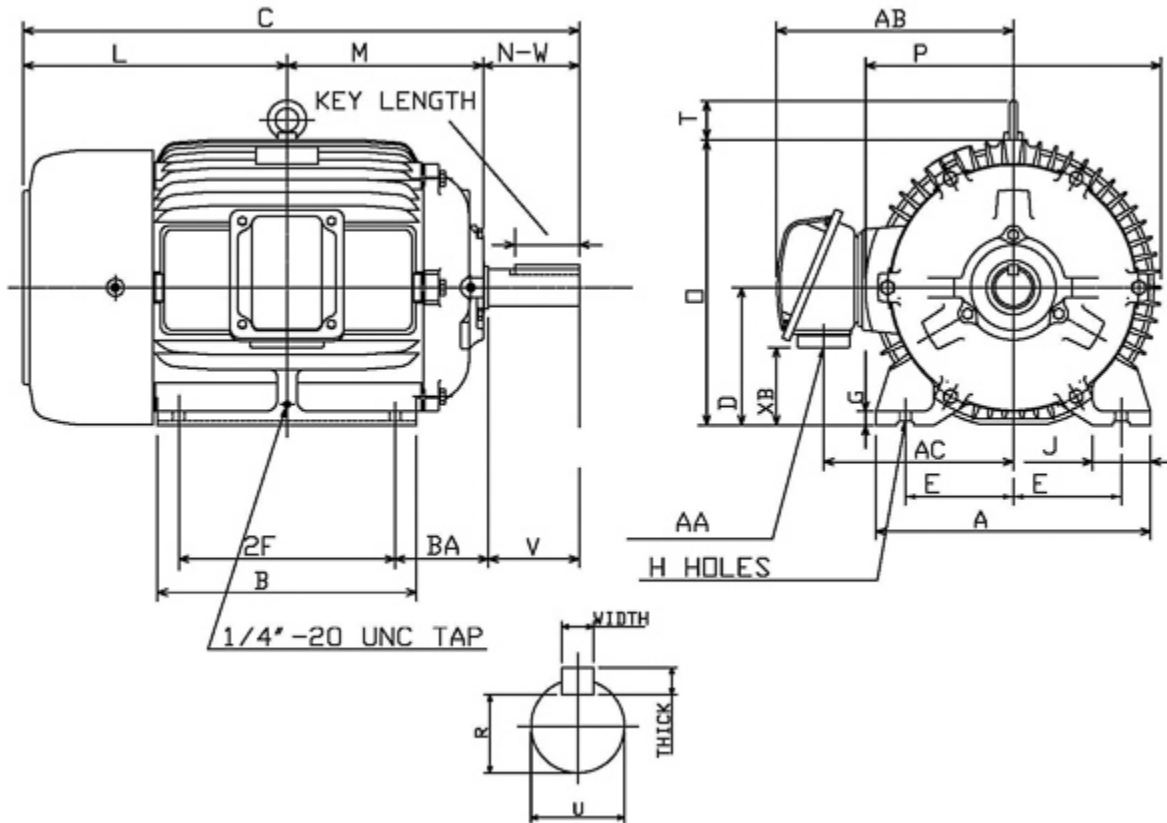

Frame Size	Mounting					A	B	C	CD	D	
	E	2F	2F2	H	BA						
254T	5	8.25		0.53	4.25	11.81	9.85	23.78		6.25	
G	J	K	L	M	O	P	T	Key			Keyseat
0.66	1.95		11.41	8.06	12.8	13.15	2.01	Width	Thick	Length	R
								0.375	0.375	2.91	1.416
Terminal Housing			Aux Box			C/D Flange					
AA	AB	AC	XB	AE	AX	BB	AH	AK	BD	AJ	BF
NPT1 1/4"	11.3	8.86	3.22								
Shaft Extension			Bearings		Approx. Weight Lbs	SPL dBA/3ft	Ins. Class	S.F.	Drive Method	Dimensions	
N-W	U	V	DE	NDE							
4	1.625	3.9	6309ZC3	6307C3	297	73	F	1.15	Direct Coupling / Belt Drive	Inches	

### Technical Data Sheet

Motor Type: AEHH8R

Catalogue No: APH0152

#### Nameplate Information

HP	Pole	RPM	Frame	Voltage	Hz	Phase
15	2	3525	254T	460	60	3
Enclosure	Ins. Class	Service Factor	Time Rating	NEMA Design	Rated Amb.	Rated Altitude
TEFC	F	1.15	Continuous	B	-40 to 40 °C	<3300 ft

#### Typical Performance

Efficiency (%)				Power Factor (%)		
Full Load		3/4 Load	1/2 Load	Full Load	3/4 Load	1/2 Load
Nom.	Min.					
92.4	91.0	92.4	91.7	91.5	90.5	86.0
Torque				Current (A)		
Full Load (lb-ft)	Locked Rotor (% FLT)	Pull Up (% FLT)	Break Down (% FLT)	No Load	Full Load	Locked Rotor
22.34	210	180	270	3.7	16.6	116
NEMA KVA Code	Inertia (WR <sup>2</sup> )			Safe Stall Time (s)		Noise Level Sound Press. dB(A)
	Rotor (lb-ft <sup>2</sup> )	NEMA Load (lb-ft <sup>2</sup> )	Max. Allowable (lb-ft <sup>2</sup> )	Cold	Hot	
G	1.088	16	41	17	12	73

#### VFD Duty Information

Speed Range			VFD		S.F.
Constant Torque	Variable Torque	Constant Power	Carrier	Type	
6-60Hz	3-60Hz	60-120Hz	≤ 5 kHz	VPWM or CPWM	1.0 Only

#### Additional Information

Bearings		Approx. Weight
DE	NDE	lbs
6309ZC3	6307C3	297

#### Hazardous Locations Information

CSA Certified	
Class I, Div 2, Groups B, C & D Class I, Zone 2, Groups IIB+H2, IIB & IIA	
Temp Code (Sinewave / VFD)	T3C / T3B