

Dimensões em polegada  
Dimensions in inches

THIS IS AN UPDATED REVISION, THE  
PREVIOUS ONE MUST BE DISREGARDED.

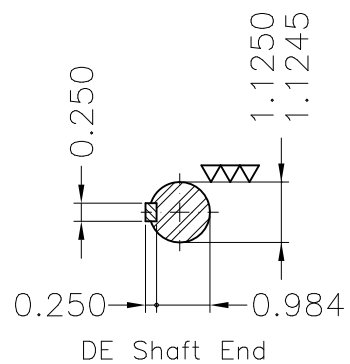
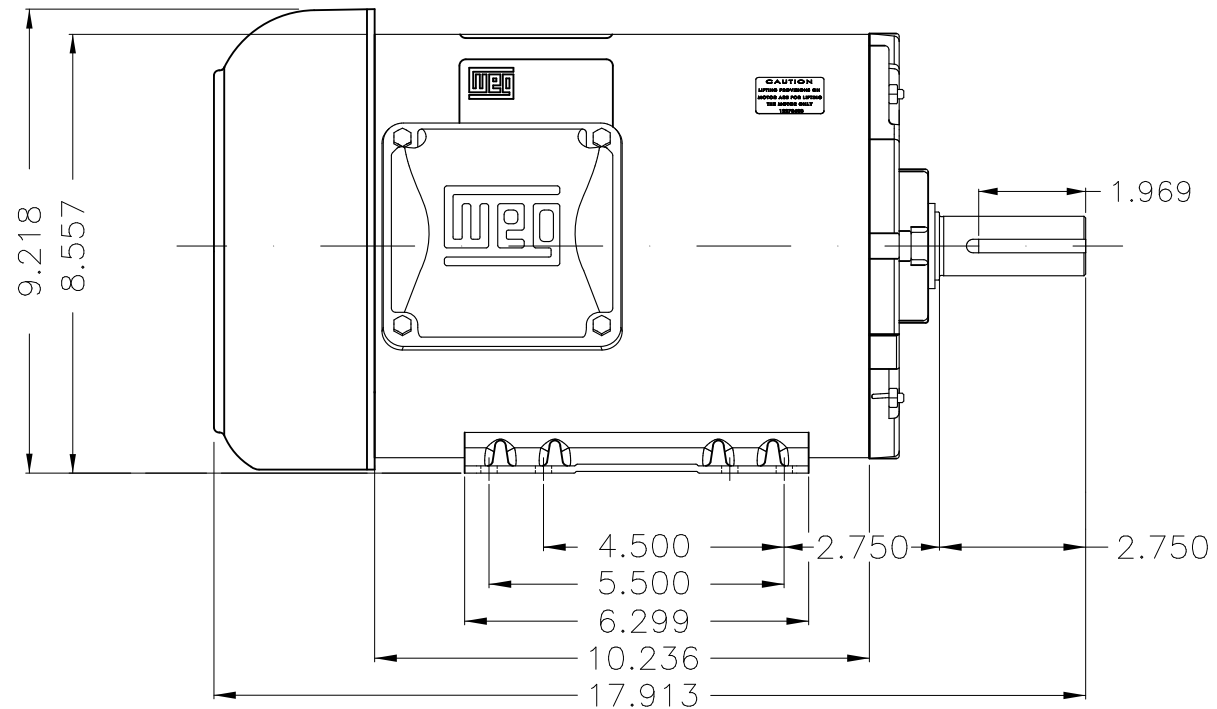
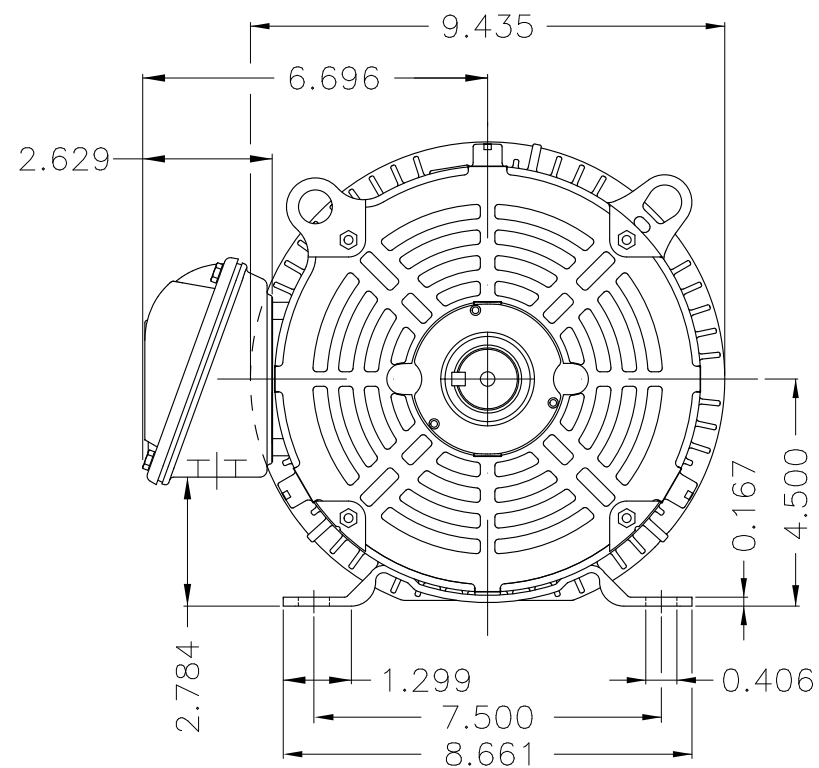
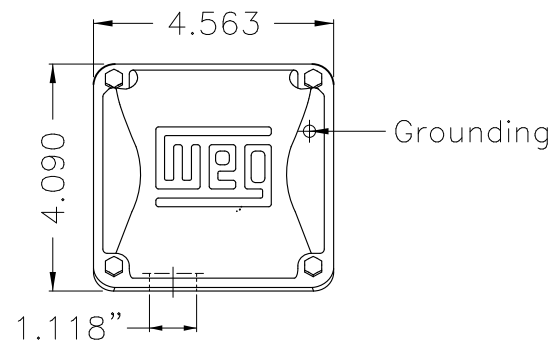

Color Munsell N 1 matte black  
Painting plan 207N  
Mounting F-1/B3R(D)

ECM	LOC	SUMMARY OF MODIFICATIONS	EXECUTED	CHECKED	RELEASED	DATE	VER
EXECUTED	USERADMIN	THREE P. MOTOR TEFC ROLLED STEEL NEMA P.					
CHECKED		FRAME 182/4T IP55 TEFC					
RELEASED		WEG code: 12675403					
REL DT	24.07.2017	WMO Jaragua do Sul	Product Engineering	SHEET	1 / 1		

3 HP 04 Poles 60Hz

A



ZME A3