

DATE
February 16, 2004

OUTLINE DIMENSIONS
3-PHASE INDUCTION MOTOR

MODEL TYPE:
ASGA

CATALOG NO.
DSO/76

FRAME NO. A56

Pole	HP	KW	Hz	VOLT	Syn. Speed R. P. M
6	3/4	.56	60	230/460	1200

Ins.	Rating	Dimensions in	Approx Weight	Bearings
F	CONT.	inch	25.08 lbs	DE: 6205ZZ NDE: 6204ZZ

OPEN DRIP - PROOF

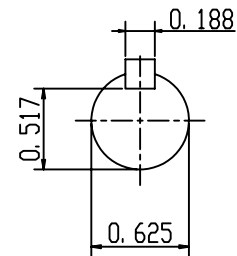
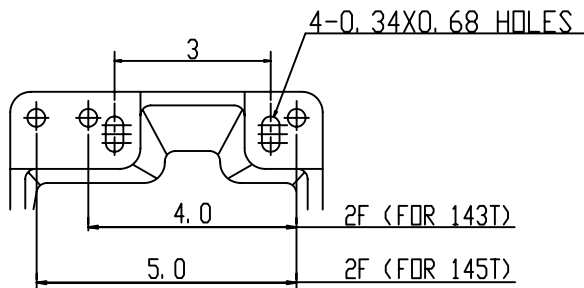
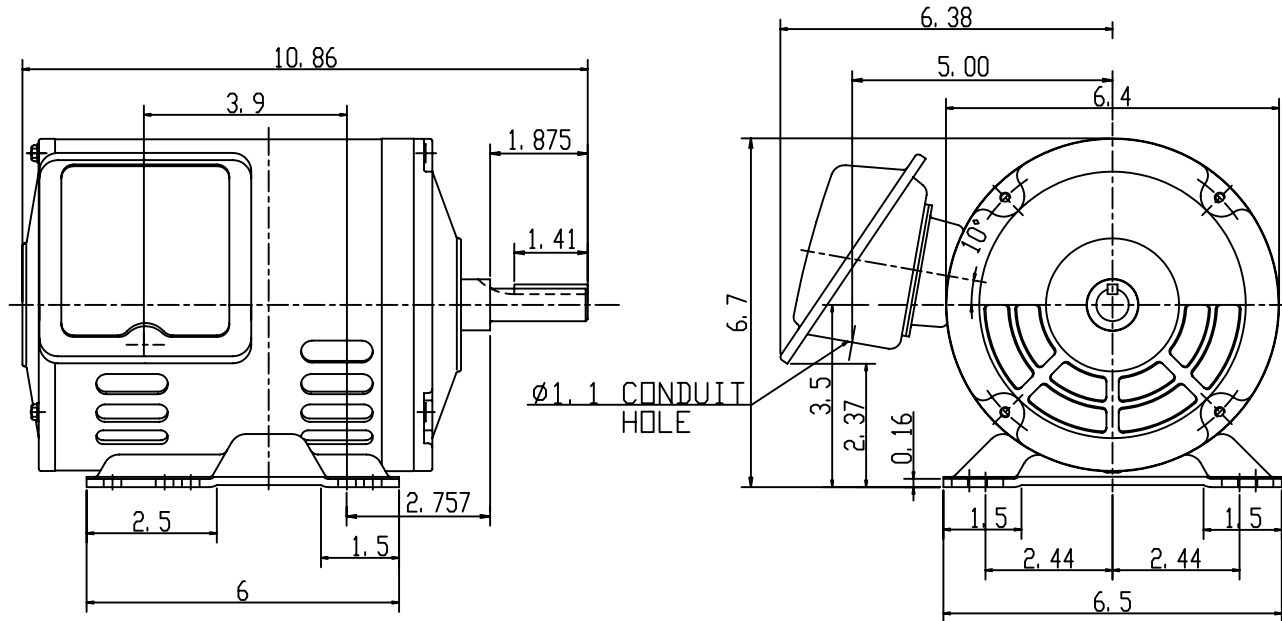

SCALE=3: 1

APPD.	W. H. TSAI	07 21 03
CHKD.	J. B. CHEN	07 20 03
DWN.	Y. Y. CHEN	07 20 03

TEC   Westinghouse

DWG NO.
31049Z105
0829