

Dimensional Drawing

Catalogue	Model	HP	Pole	kW	Rating	Voltage	Hz	RPM
PDH02025	AEHH8N	20	2	15	Continuous	575 V	60	3600

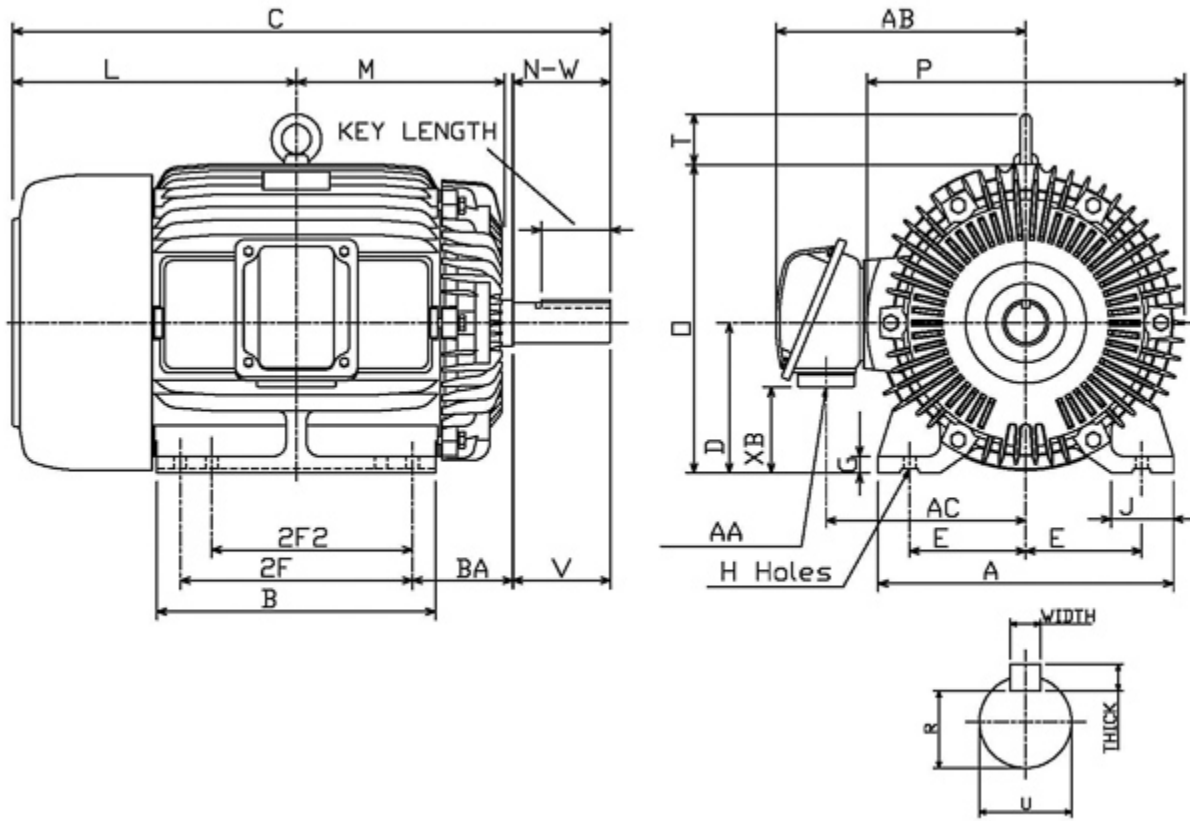

Frame Size	Mounting					A	B	C	CD	D	
	E	2F	2F2	H	BA						
256T	5	10	8.25	0.53	4.25	11.8	11.8	25.44		6.25	
G	J	K	L	M	O	P	T	Key			Keyseat
0.65	1.95		12.19	8.94	12.83	13.15	1.97	Width	Thick	Length	R
								0.375	0.375	2.91	1.416
Terminal Housing			Aux Box			C/D Flange					
AA	AB	AC	XB	AE	AX	BB	AH	AK	BD	AJ	BF
1.25 NPT	11.3	8.86	3.22								
Shaft Extension			Bearings		Approx. Weight Lbs	SPL dBA/3ft	Ins. Class	S.F.	Drive Method	Dimensions	
N-W	U	V	DE	NDE							
4	1.625	3.9	6309ZZ	6307ZZ	345	73	F	1.15	Direct Coupling / Belt Drive	Inches	

Technical Data Sheet

Motor Type: AEHH8N

Catalogue No: PDH02025

Nameplate Information

HP	Pole	RPM	Frame	Voltage	Hz	Phase
20	2	3520	256T	575	60	3
Enclosure	Ins. Class	Service Factor	Time Rating	NEMA Design	Rated Amb.	Rated Altitude
TEFC	F	1.15	Continuous	B	-40 to 40 °C	<3300 ft

Typical Performance

Efficiency (%)				Power Factor (%)		
Full Load		3/4 Load	1/2 Load	Full Load	3/4 Load	1/2 Load
Nom.	Min.					
92.4	91.0	93.0	93.6	92.5	91.5	88.0
Torque				Current (A)		
Full Load (lb-ft)	Locked Rotor (% FLT)	Pull Up (% FLT)	Break Down (% FLT)	No Load	Full Load	Locked Rotor
29.83	210	180	260	3.3	17.5	116
NEMA KVA Code	Inertia (WR ²)			Safe Stall Time (s)		Noise Level Sound Press. dB(A)
	Rotor (lb-ft ²)	NEMA Load (lb-ft ²)	Max. Allowable (lb-ft ²)	Cold	Hot	
G	1.407	21.0	42.0	17	12	73

VFD Duty Information

Speed Range			VFD		S.F.
Constant Torque	Variable Torque	Constant Power	Carrier	Type	
6-60Hz	3-60Hz	60-90Hz	≤ 5 kHz	VPWM or CPWM	

Additional Information

Bearings		Approx. Weight
DE	NDE	lbs
6309ZZ	6307ZZ	345

Hazardous Locations Information

CSA Certified	
Class I, Div 2, Groups B, C & D	
Class I, Zone 2, Groups IIB+H2, IIB & IIA	
Temp Code (Sinewave / VFD)	T3C / T3B