

Dimensões em polegada
Dimensions in inches

THIS IS AN UPDATED REVISION, THE
PREVIOUS ONE MUST BE DISREGARDED.

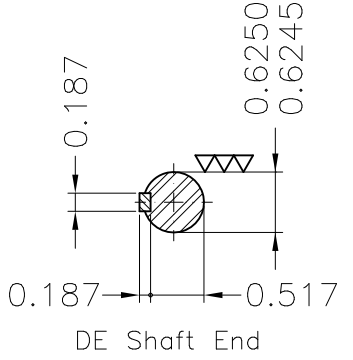
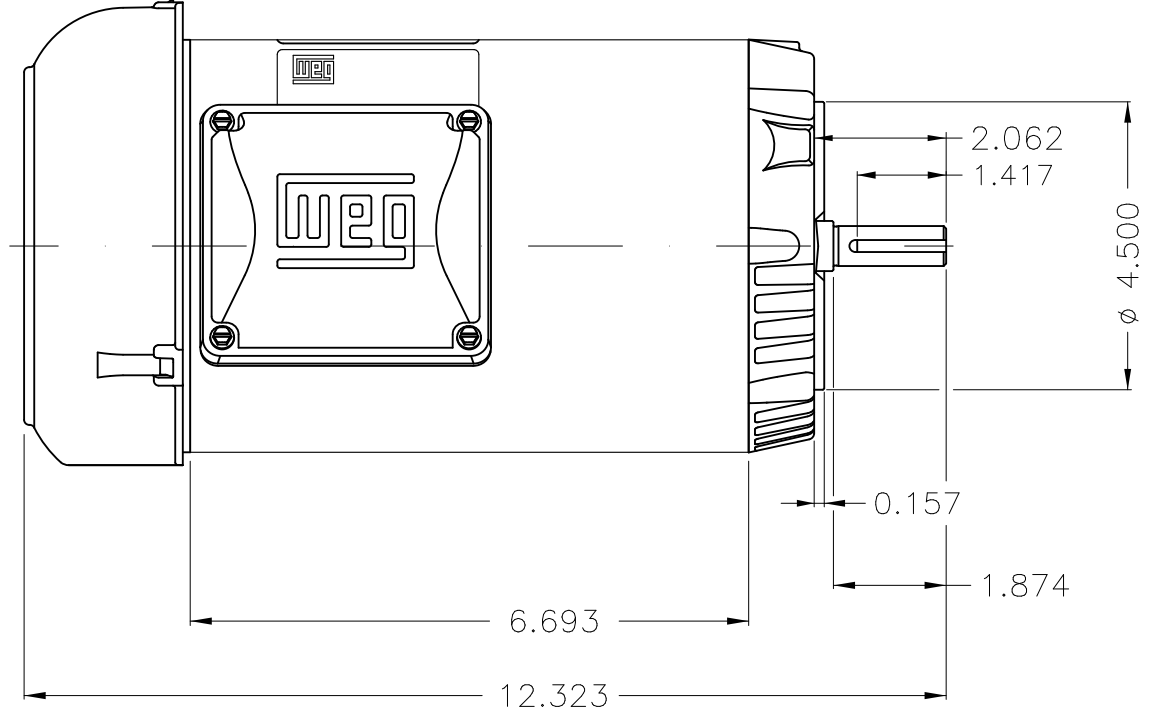
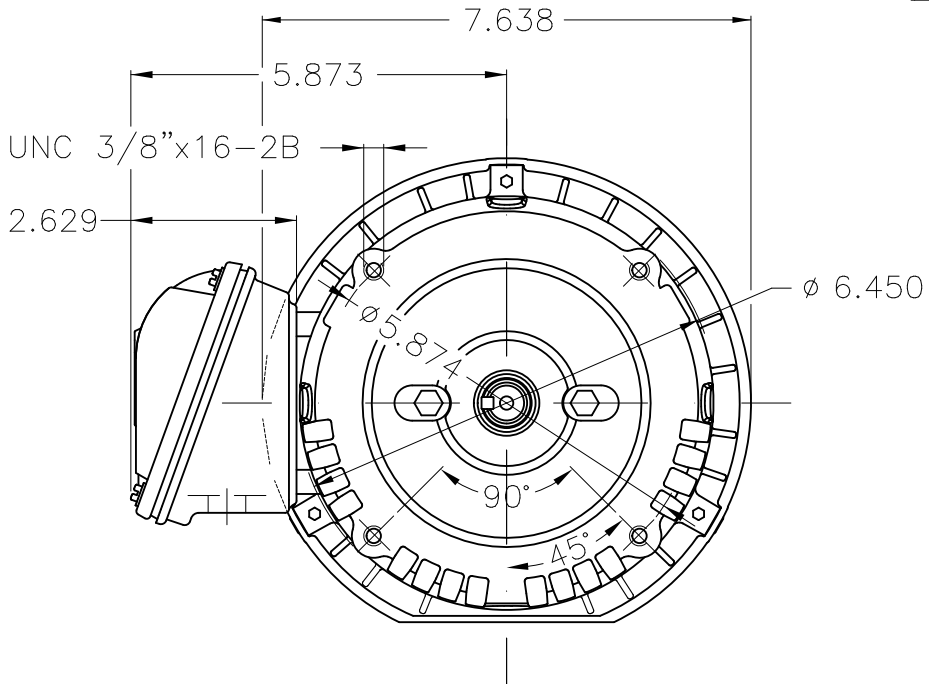
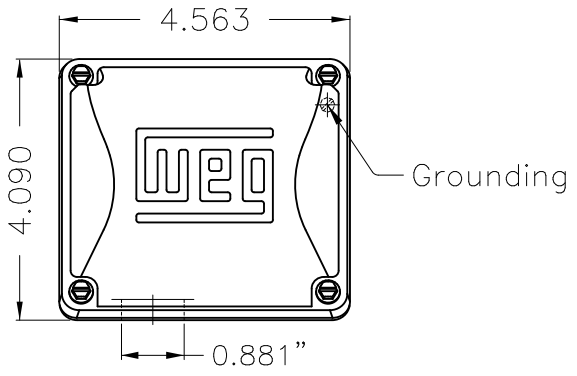
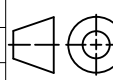

Color Munsell N 1 matte black
Painting plan 207N
Mounting F-1/B14R(D)

ECM	LOC	SUMMARY OF MODIFICATIONS			EXECUTED	CHECKED	RELEASED	DATE	VER
EXECUTED	USERADMIN	 THREE PHASE MOTOR TEFC ROLLED STEEL FRAME 56C IP55 TEFC WEG code: 12894703							
CHECKED									
RELEASED									
REL DT	24.07.2017	WMO	Jaragua do Sul	Product Engineering	SHEET	1 / 1			

0.5 HP 06 Poles 60Hz

A

