

DATE
February 13, 2004

OUTLINE DIMENSIONS
SINGLE-PHASE INDUCTION MOTOR

MODEL TYPE:
BEGCFD

CATALOG NO.
S0/74

FRAME NO. 56

Pole	HP	KW	Hz	VOLT	Syn. Speed R. P. M
4	3/4	.55	60	115/230	1800

Ins.	Rating	Dimensions in	Approx Weight	Bearings
B	CONT.	inch	36 lbs.	DE: 6205ZZ NDE: 6203ZZ

Totally Enclosed Fan-cooled Capacitor Starting Type. Squirrel Rotor.

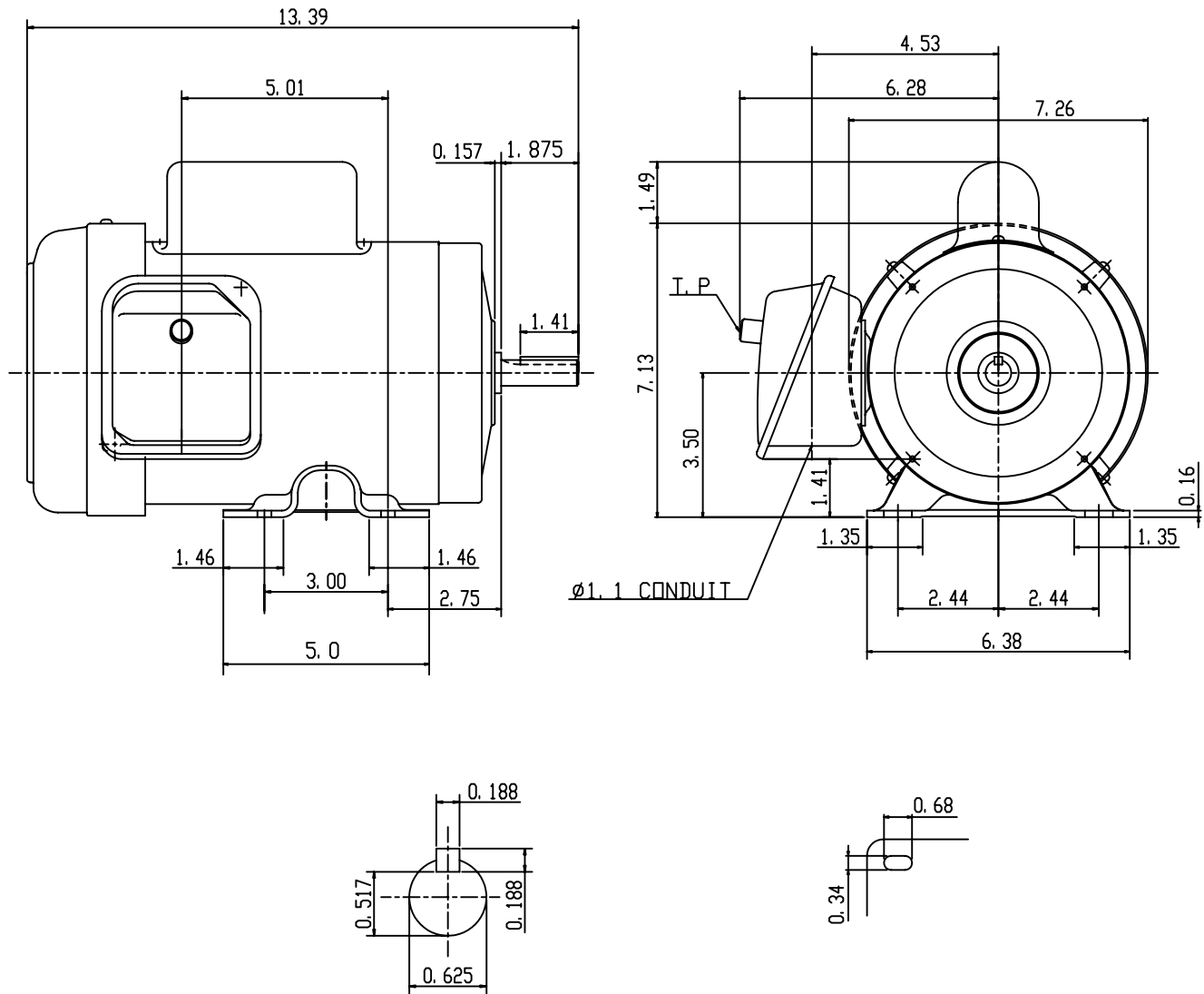

SCALE=1:3

1					
---	--	--	--	--	--

APPD.	W. H. TSAI	03 27 03
CHKD.	J. B. CHEN	03 27 03
DWN.	Y. Y. CHEN	03 27 03



DWG NO.
31049J754
0001