

Dimensões em polegada
Dimensions in inches

THIS IS AN UPDATED REVISION, THE
PREVIOUS ONE MUST BE DISREGARDED.

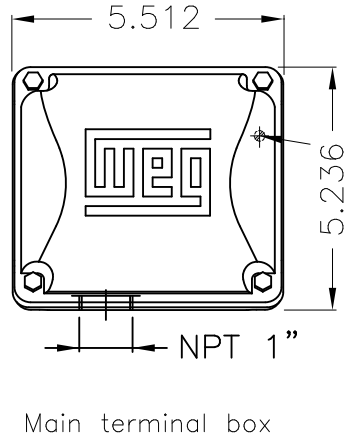

Grounding for leads 2-10 mm² / 14-7 AWG

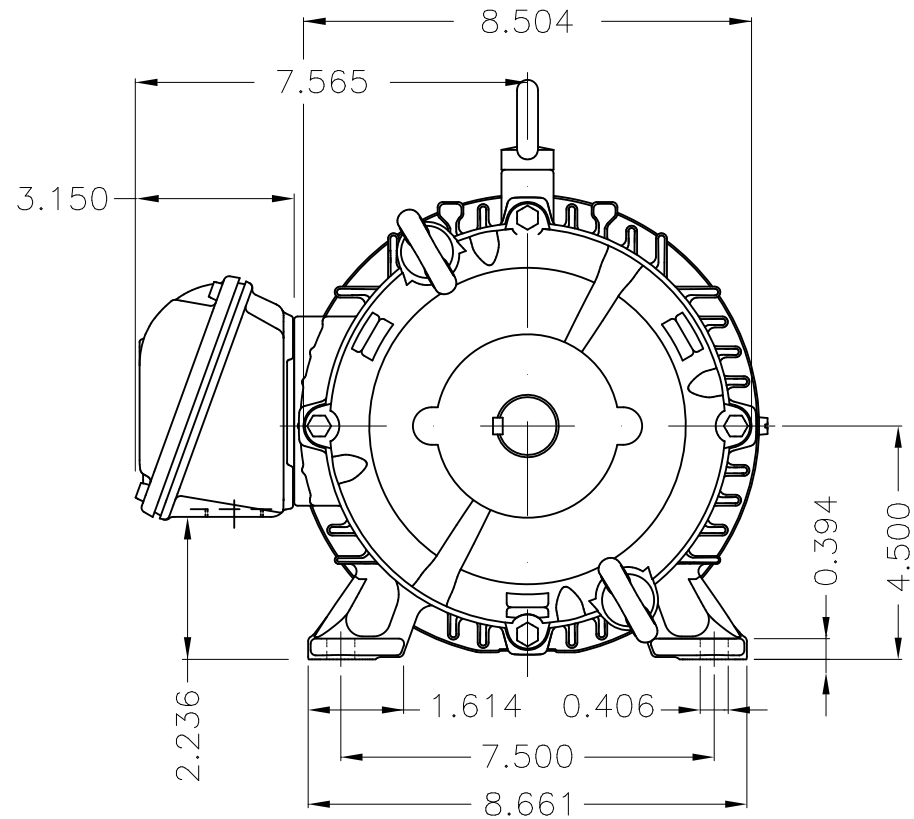
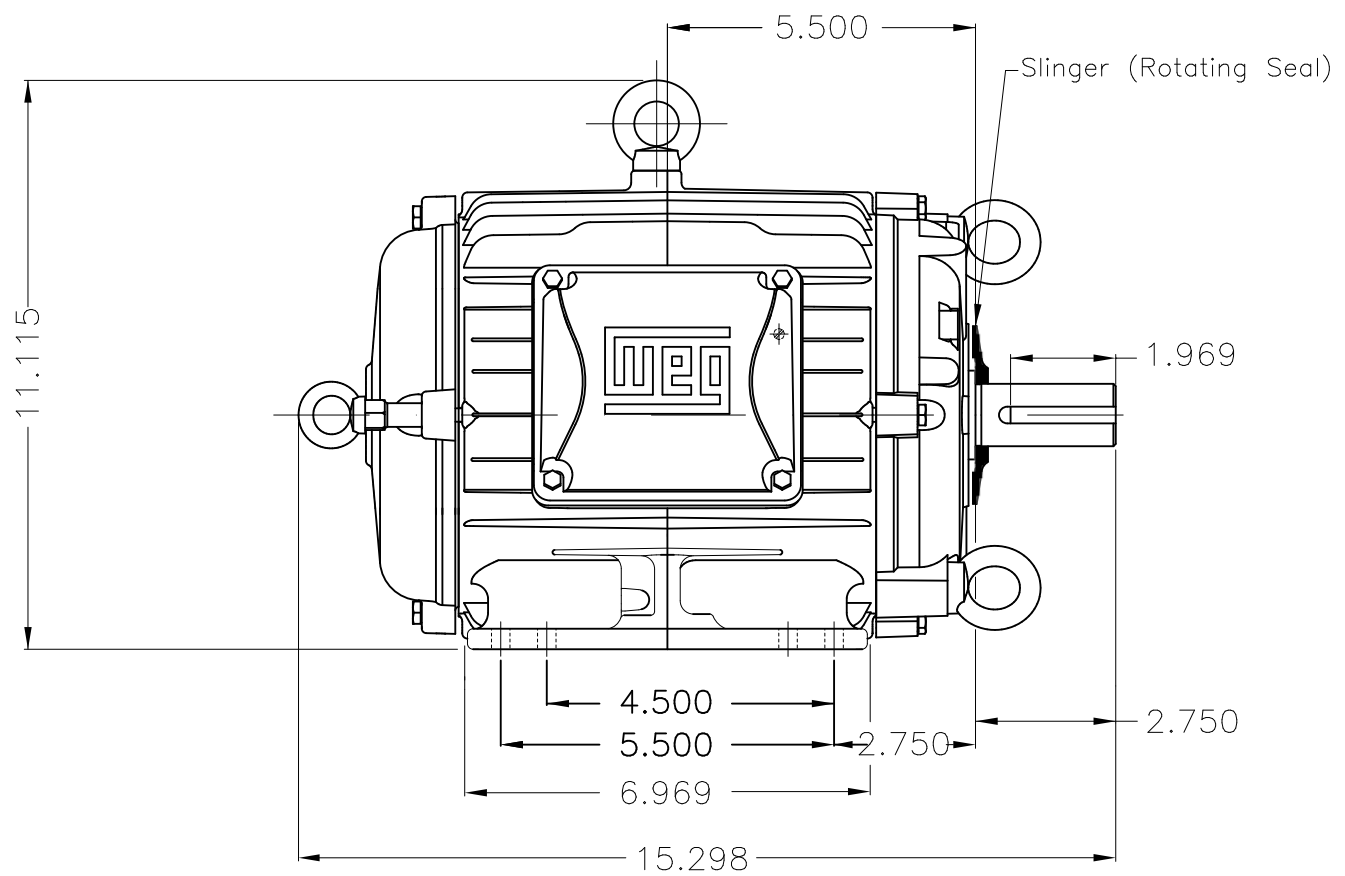

Slinger (Rotating Seal)

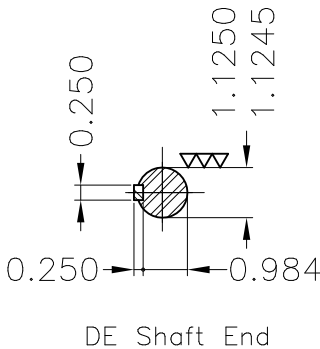

DE Shaft End

Without fan
Without fan cover
Color RAL 5009
Painting plan 202E
Mounting B3R(D)

ECM	LOC	SUMMARY OF MODIFICATIONS			EXECUTED	CHECKED	RELEASED	DATE	VER
EXECUTED	USERADMIN		THREE PH W22 MOTOR COOLING TOWER NEMA EF						
CHECKED			FRAME 182/4T IP55 TEAO						
RELEASED			WEG code: 12127829						
REL DT	24.07.2017	WMO	Jaragua do Sul	Product Engineering	SHEET	1 / 1			

5 HP 04 Poles 60Hz

A

