

**Dimensional Drawing**

Catalogue	Model	HP	Pole	kW	Rating	Voltage	Hz	RPM
RD00345-56	ASGH	3	4	2.2	0	575 V	0	1800

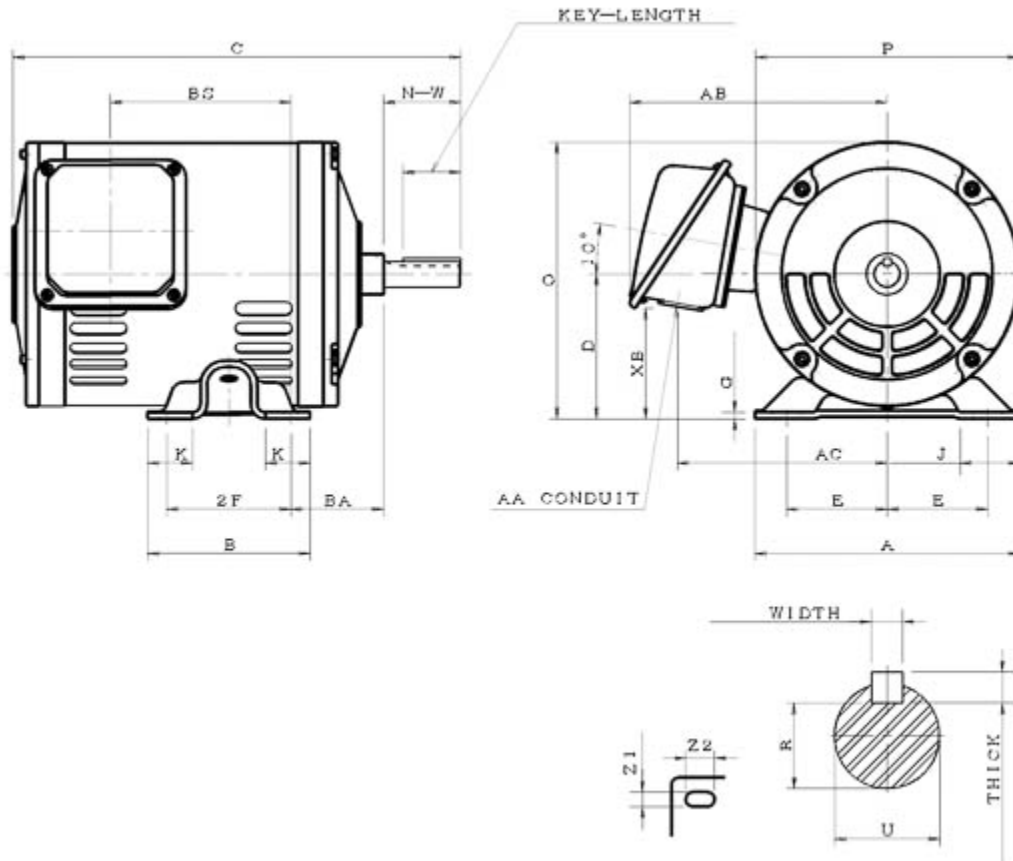

ASGH-SMP-2

Frame Size	Mounting					A	B	C	CD	D	
	E	2F	2F2	H	BA						
56	2.44	3		0.34x0.68	2.75	6.42	4.18	11.84		3.5	
G	J	K	L	M	O	P	T	Key			Keyseat
0.16	1.5	1.46			6.7	6.4		Width	Thick	Length	R
								0.188	0.188	1.41	0.517
Terminal Housing				Aux Box		C/D Flange					
AA	AB	AC	XB	AE	AX	BB	AH	AK	BD	AJ	BF
1.1	6.2	4.93	2.66								
Shaft Extension			Bearings		Approx. Weight Lbs	SPL dBA/3ft	Ins. Class	S.F.	Drive Method	Dimensions	
N-W	U	V	DE	NDE							
1.875	0.625		0	0	0	0	0	0.00	Direct Coupling / Belt Drive	Inches	

### Technical Data Sheet

Motor Type: ASGH

Catalogue No: RD00345-56

#### Nameplate Information

HP	Pole	RPM	Frame	Voltage	Hz	Phase
3	4	0	56	575	0	0
Enclosure	Ins. Class	Service Factor	Time Rating	NEMA Design	Rated Amb.	Rated Altitude
ODP	0	0.00	0	0	0 °C	0

#### Typical Performance

Efficiency (%)				Power Factor (%)		
Full Load		3/4 Load	1/2 Load	Full Load	3/4 Load	1/2 Load
Nom.	Min.					
0.0	0.0	0.0	0.0	0.0	0.0	0.0
Torque				Current (A)		
Full Load (lb-ft)	Locked Rotor (% FLT)	Pull Up (% FLT)	Break Down (% FLT)	No Load	Full Load	Locked Rotor
0.00	0	0	0	0.0	0.0	0
NEMA KVA Code	Inertia (WR <sup>2</sup> )			Safe Stall Time (s)		Noise Level Sound Press. dB(A)
	Rotor (lb-ft <sup>2</sup> )	NEMA Load (lb-ft <sup>2</sup> )	Max. Allowable (lb-ft <sup>2</sup> )	Cold	Hot	
0	0.000	0	0	0	0	0

#### VFD Duty Information

Speed Range			VFD		S.F.
Constant Torque	Variable Torque	Constant Power	Carrier	Type	
0	0	0	0	0	0

#### Additional Information

Bearings		Approx. Weight
DE	NDE	lbs
0	0	0

#### Hazardous Locations Information

0	
0	
0	
Temp Code (Sinewave / VFD)	0 / 0