

DATE  
APRIL 30, 2004  
CATALOG NO.  
XV0024C

OUTLINE DIMENSIONS  
3-PHASE INDUCTION MOTOR

MOTOR TYPE:  
AEUHXF  
FRAME NO. 145TC

Pole	HP	KW	Hz	VOLT	Syn. Speed RPM
4	2	1.5	60	230/460	1800

Ins	Rating	Dimension in	Approx Weight	Bearings
F	CONT.	inches	102 lbs.	DE: 6205ZZ NDE: 6205ZZ

Totally Enclosed Fan-Cooled Type, Squirrel-Cage Rotor.

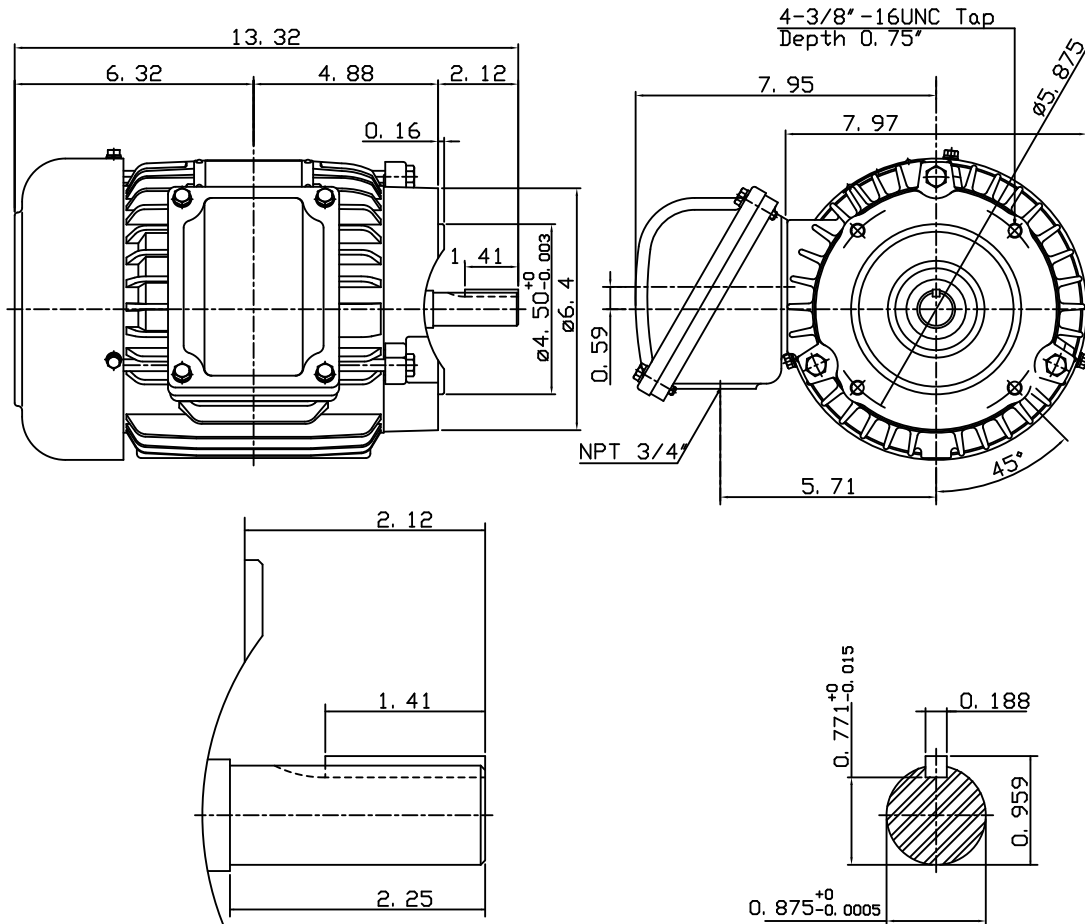

NOTE:  
1. EXPLOSION PROOF:  
CLASS I GROUP D AND  
CLASS II GROUP E, F, G.

DWN.	J. H. LIANG	11-12-98
CHKD.	C. S. LO	11-23-98
APPD.	Y. B. HUANG	11-23-98

TECO Westinghouse

DWG NO.  
31049U550003