

Dimensões em polegada
Dimensions in inches

THIS IS AN UPDATED REVISION, THE
PREVIOUS ONE MUST BE DISREGARDED.

Grounding for leads 5.2–35 mm² / 10–2 AWG

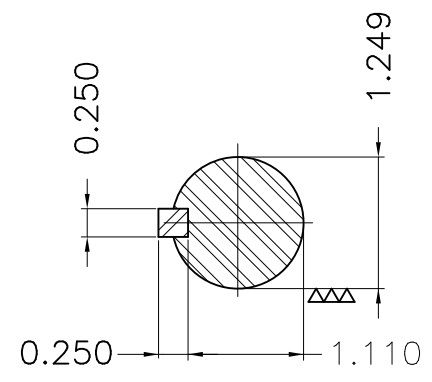
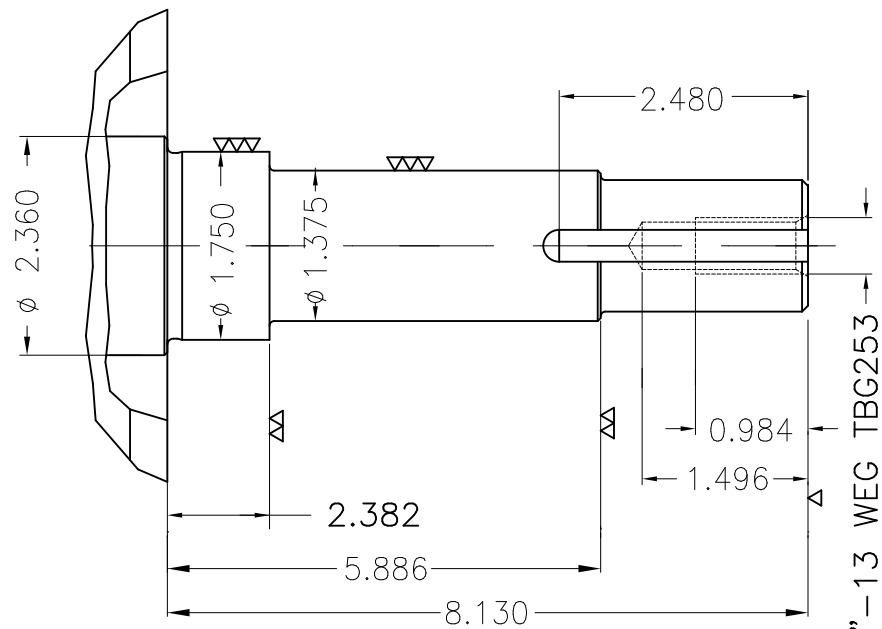
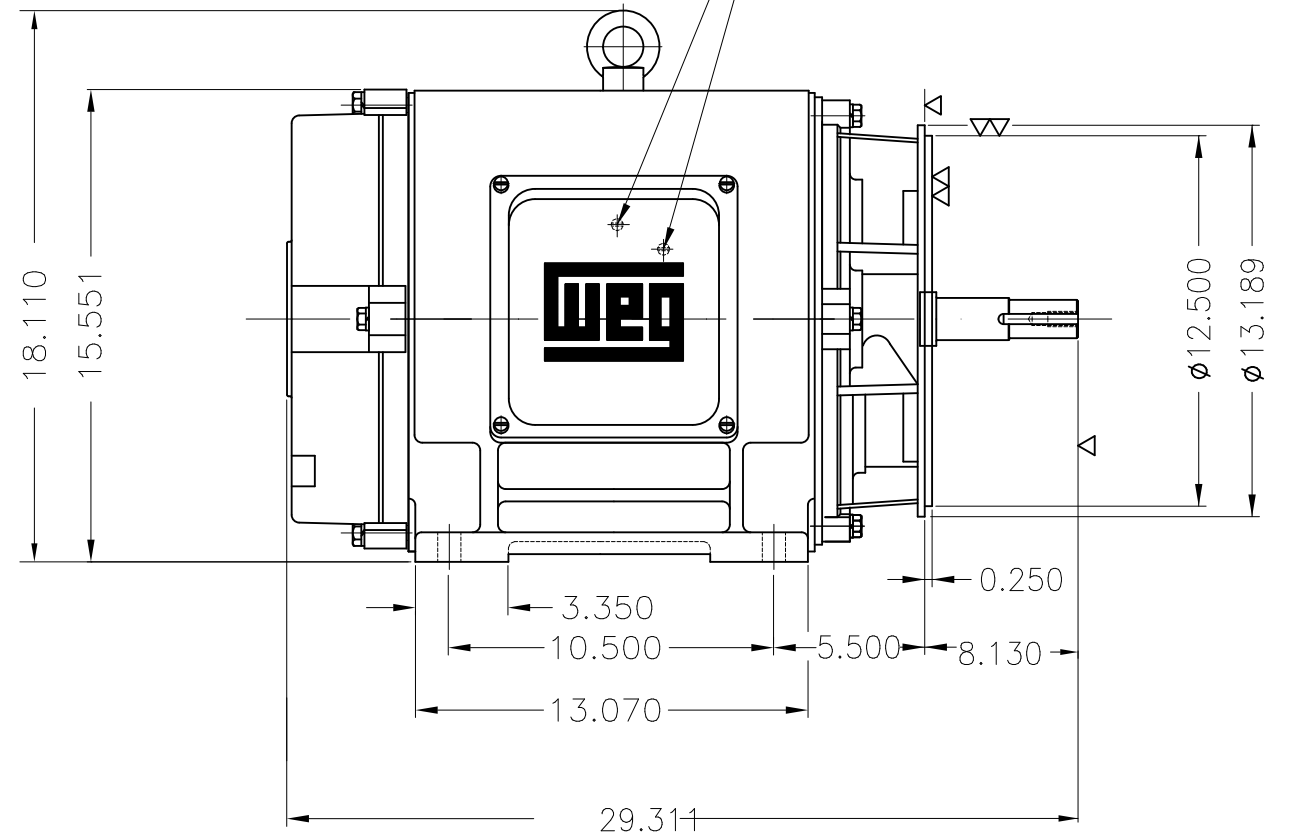
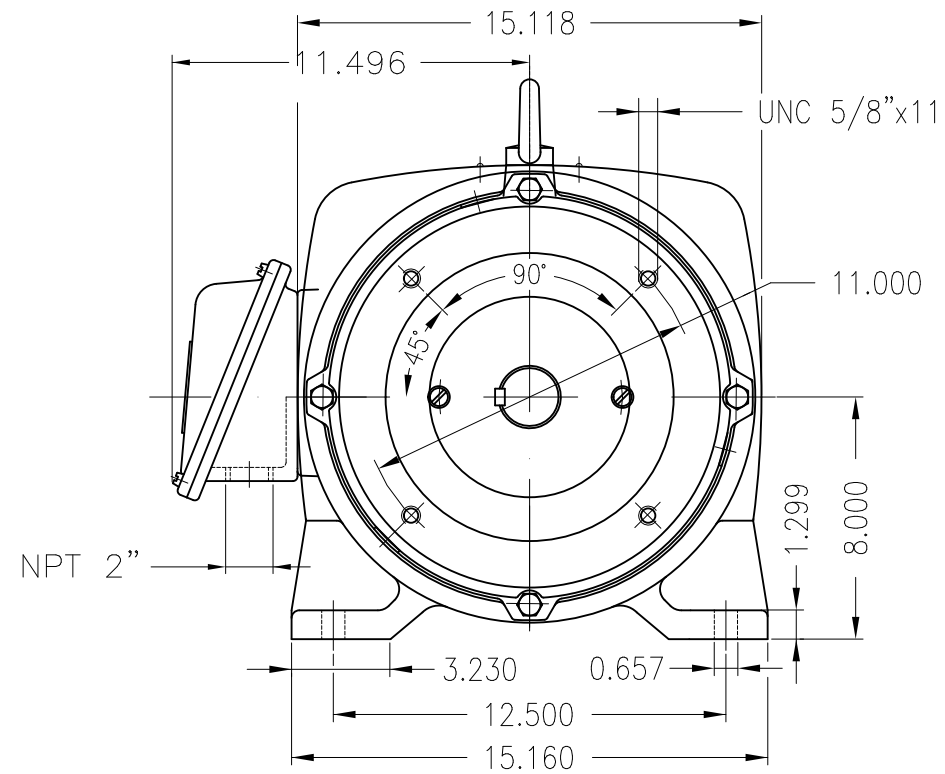

EUNC 1/2"-13 WEG TBG253

Color RAL 5009
Painting plan 203A
Mounting B34R(D)

ECM	LOC	SUMMARY OF MODIFICATIONS	EXECUTED	CHECKED	RELEASED	DATE	VER
EXECUTED	USERADMIN	THREE PHASE MOTOR JP NEMA PREMIUM EFF.					
CHECKED		FRAME 324JP IP23 ODP					
RELEASED		WEG code: 12368461					
REL DT	24.07.2017	WMO Jaragua do Sul	Product Engineering	SHEET	1 / 1		

25 HP 06 Poles 60Hz

A

