

DATE JULY 11, 2005	OUTLINE DIMENSIONS 3-PHASE INDUCTION MOTOR	MODEL TYPE: AEGA
CATALOG NO. G0024		FRAME NO. C56

Pole	HP	KW	Hz	VOLT	Syn. Speed R. P. M
4	2		60	230/460	1800

Ins.	Rating	Dimensions in	Approx Weight	Bearings
F	CONT.	inch	30.92 lbs	DE: 6205ZZ NDE: 6204ZZ

Totally Enclosed Fan Cooled  
Squirrel-Cage

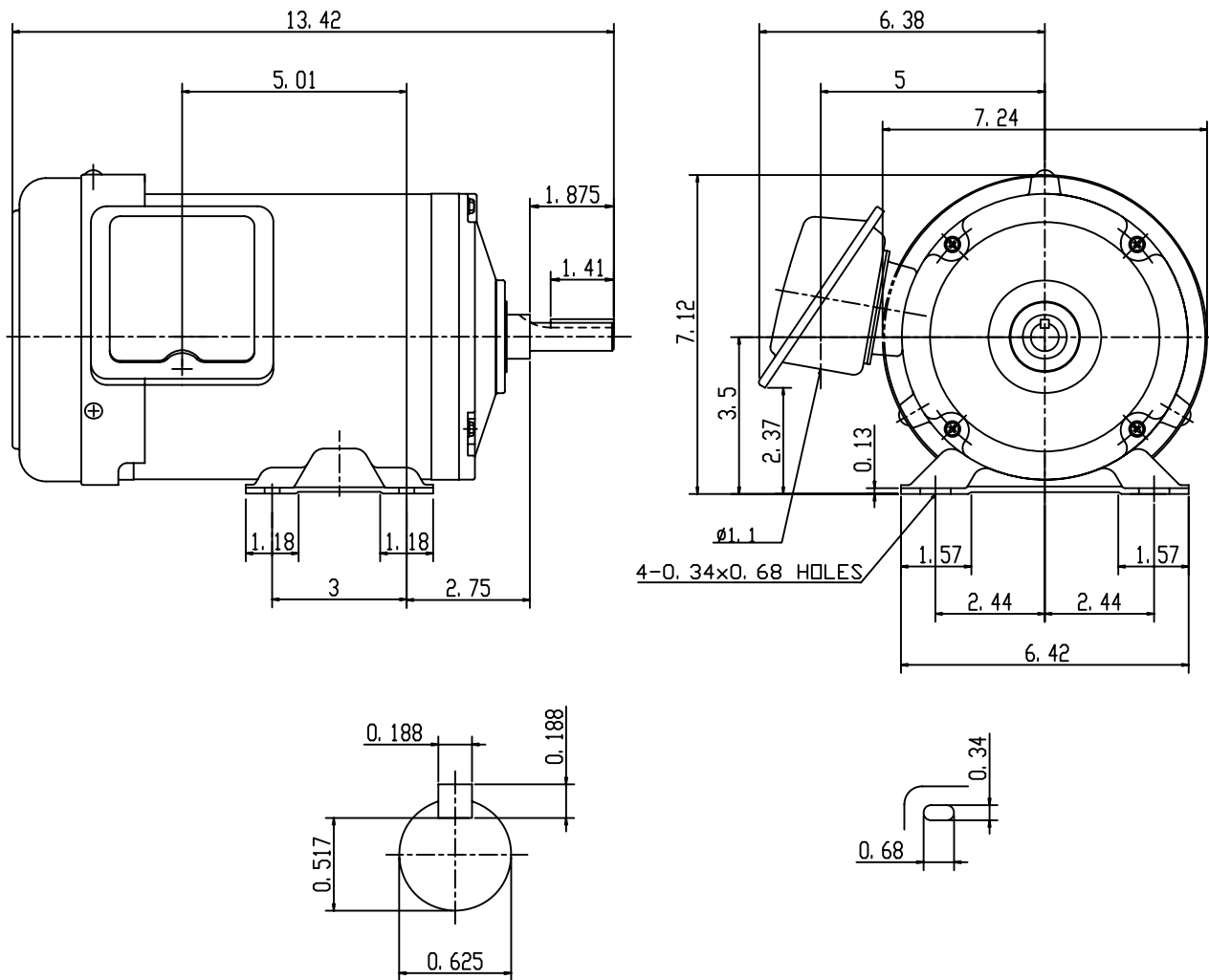

SCALE 4: 1

APPD.	W. H. TSAI	07 21 03	TECO  Westinghouse 	DWG NO.	31049Z105	
CHKD.	J. B. CHEN	07 20 03				
DWN.	Y. Y. CHEN	07 20 03				2085