

DATE
Sept. 8, 2005
CAT. #: EPO1065

OUTLINE DIMENSIONS
3-PHASE INDUCTION MOTOR

MOTOR TYPE:
AEHH8N
FRAME NO. 256T

Pole	HP	kW	Hz	VOLT	Syn. Speed r/min(rpm)
6	10	7.5	60	575	1200

Ins	Rating	Dimension in	Approx Weight	Bearings
F	CONT.	inches	334 lbs.	DE: 6309ZZ NDE: 6307ZZ

Totally Enclosed Fan-Cooled Type. Squirrel-cage Rotor.

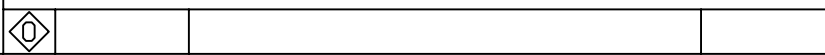
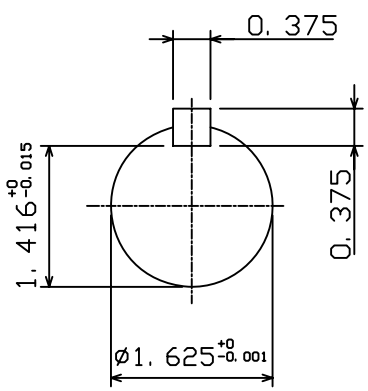
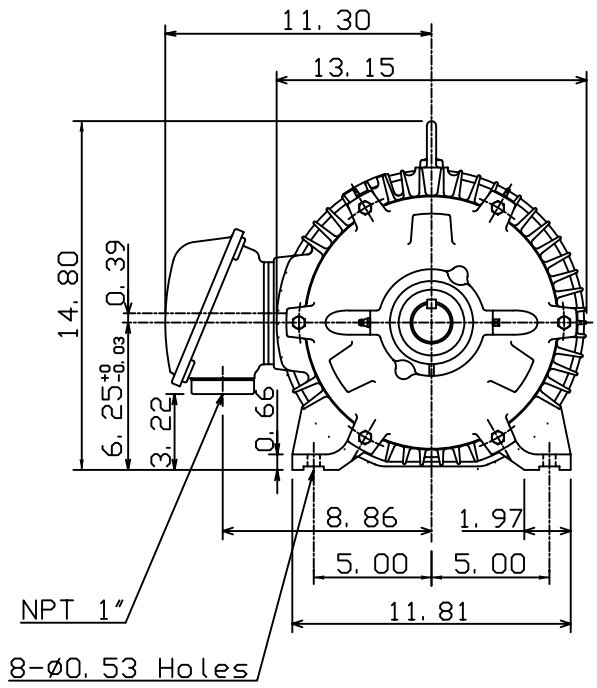
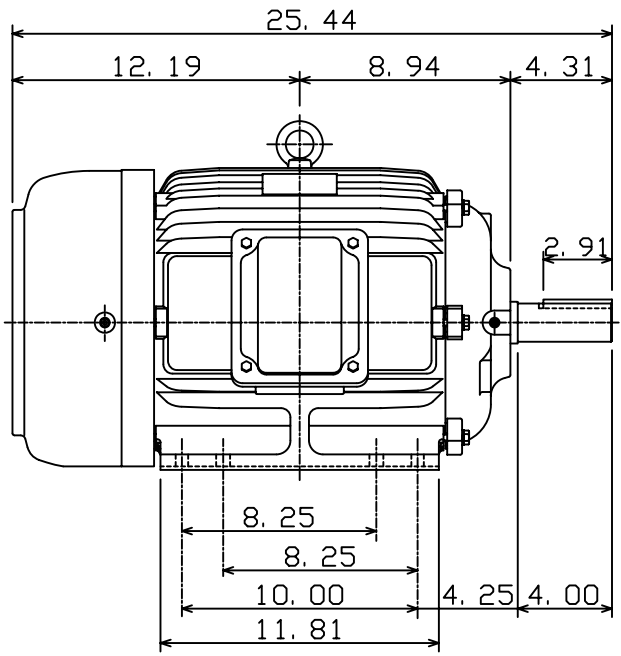

DWN.	K. L. KUO	01-10-05
CHKD.	C. H. KAO	01-28-05
APPD.	M. C. TSAI	01-28-05



DWG NO.
31057H358520