

TYPE	OUTPUT		POLE	TIME RATING	VOLTAGE V	Hz	SYN SPEED R.P.M
	HP.	KW.					
ASHH	500	373	6	CDNT.	460	60	1200

DRIP PROOF TYPE, SQUIRREL-CAGE ROTOR

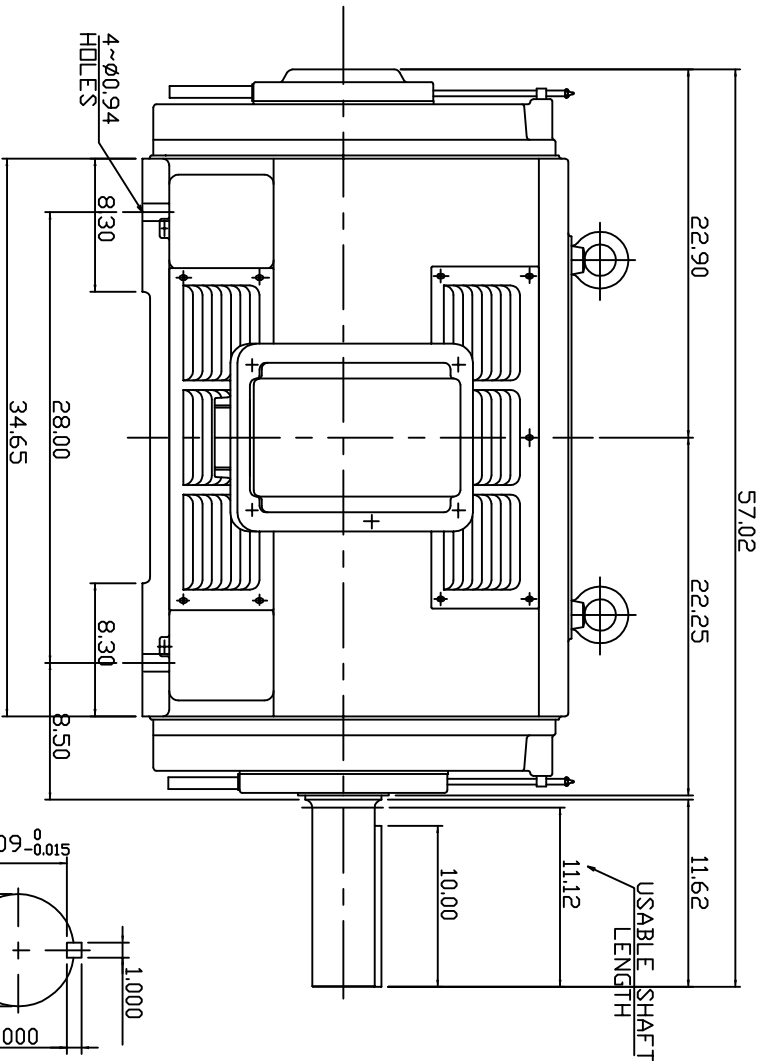
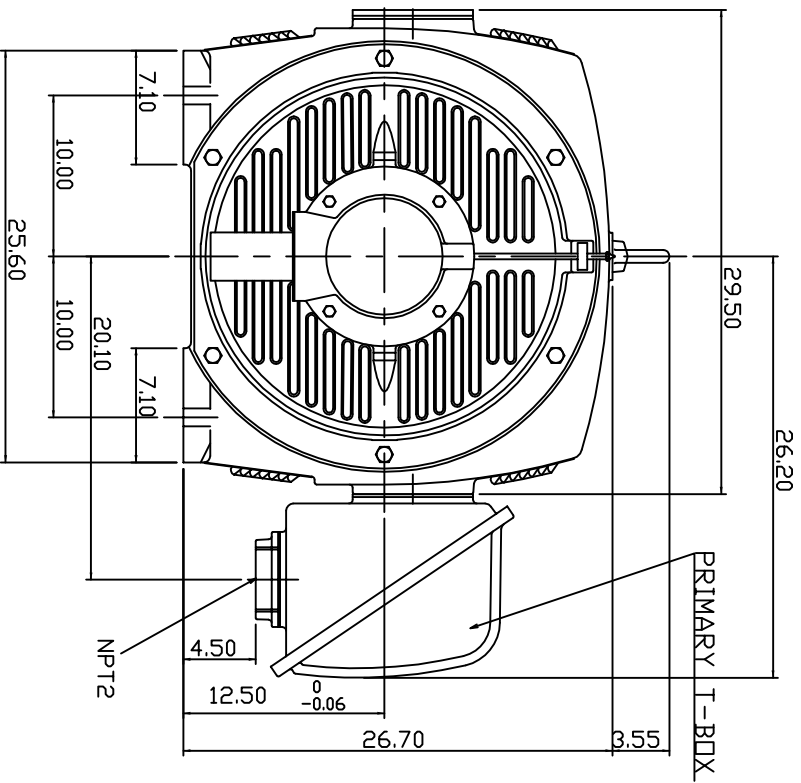

- NOTE:
 1. DIMENSIONS IN INCH
 2. FRAME NO. 5009B
 3. F CLASS INSULATION
 4. FOR DIRECT FLEXIBLE COUPLING
 5. ENCLOSURE: IP22
 6. BEARING SIZE: DPP, DRIVE END 6324
 7. MOTOR APPROX. WEIGHT: 4075 LBS

TW-56C

DWN.	HCHEN	JUL. 05. 2010
CHKD.	W.W/ENG	JUL. 05. 2010
APPD.	T.HSIAD	JUL. 05. 2010

DATE	JULY 9, 2010	OUTLINE DIMENSIONS
CATALOG NO.	DHP5006	
3-PHASE INDUCTION MOTOR		



DWG NO. 3A049DTA0013-9
 REV: 00