

Dimensional Drawing

Catalogue	Model	HP	Pole	kW	Rating	Voltage	Hz	RPM
SDP3002	ASHH	300	2	224	Continuous	460 V	60	3600

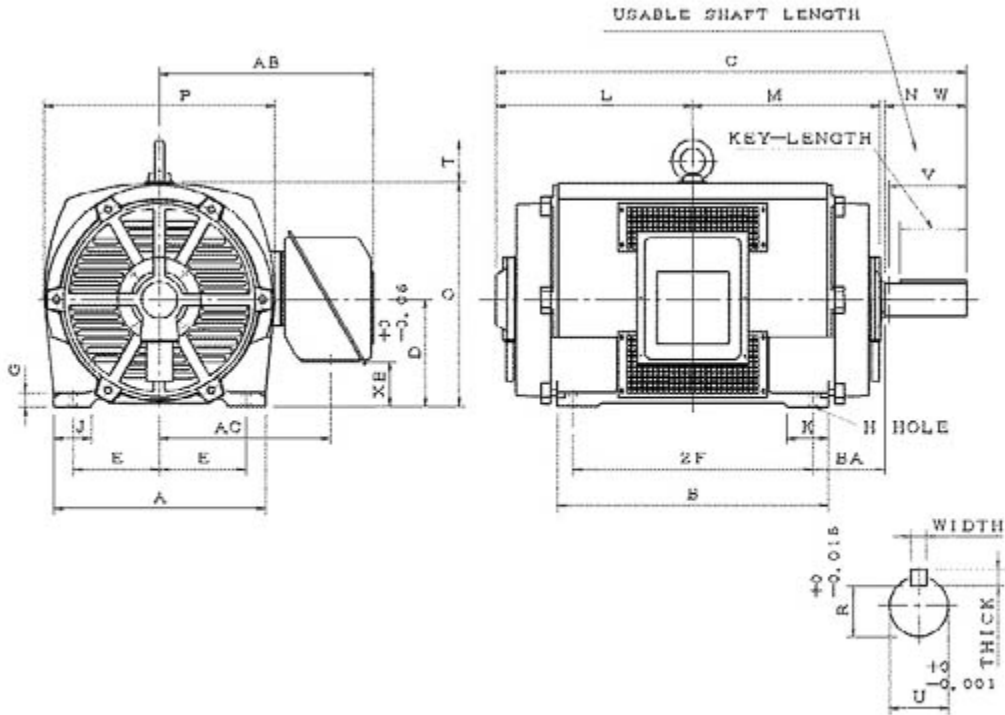

ASHH-HMP-1 1 0

Frame Size	Mounting					A	B	C	CD	D	
	E	2F	2F2	H	BA						
445TS	9	16.5		0.81	7.5	22.05	19.7	36.35		11	
G	J	K	L	M	O	P	T	Key			Keyseat
1.4	3.95	3.75	15.85	15.25	22.15	22.05	3.55	Width	Thick	Length	R
								0.625	0.625	3.03	2.021
Terminal Housing				Aux Box		C/D Flange					
AA	AB	AC	XB	AE	AX	BB	AH	AK	BD	Aj	BF
	21.25	16.75	4.65								
Shaft Extension			Bearings		Approx. Weight Lbs	SPL dBA/3ft	Ins. Class	S.F.	Drive Method	Dimensions	
N-W	U	V	DE	NDE							
4.75	2.375	4.5	6314C3	6314C3	1320	86	F	1.15	Direct Coupling	Inches	

Technical Data Sheet

Motor Type: ASHH

Catalogue No: SDP3002

Nameplate Information

HP	Pole	RPM	Frame	Voltage	Hz	Phase
300	2	3553	445TS	460	60	3
Enclosure	Ins. Class	Service Factor	Time Rating	NEMA Design	Rated Amb.	Rated Altitude
ODP	F	1.15	Continuous	B	-40 to 40 °C	<3300 ft

Typical Performance

Efficiency (%)				Power Factor (%)		
Full Load		3/4 Load	1/2 Load	Full Load	3/4 Load	1/2 Load
Nom.	Min.					
95.4	94.5	94.5	93.4	89.0	87.3	84.3
Torque				Current (A)		
Full Load (lb-ft)	Locked Rotor (% FLT)	Pull Up (% FLT)	Break Down (% FLT)	No Load	Full Load	Locked Rotor
443.00	105	97	205	81.7	331.0	2200
NEMA KVA Code	Inertia (WR ²)			Safe Stall Time (s)		Noise Level Sound Press. dB(A)
	Rotor (lb-ft ²)	NEMA Load (lb-ft ²)	Max. Allowable (lb-ft ²)	Cold	Hot	
G	20.000	246	246	19	14	86

VFD Duty Information

Speed Range			VFD		S.F.
Constant Torque	Variable Torque	Constant Power	Carrier	Type	
6-60Hz	3-60Hz	60-120Hz	≤ 5 kHz	VPWM or CPWM	1.0 Only

Additional Information

Bearings		Approx. Weight
DE	NDE	lbs
6314C3	6314C3	1320

Hazardous Locations Information

N/A	
Temp Code (Sinewave / VFD)	/