

Dimensional Drawing

Catalogue	Model	HP	Pole	kW	Rating	Voltage	Hz	RPM
RD0032-56	ASGH	3	2	2.2		V		3600

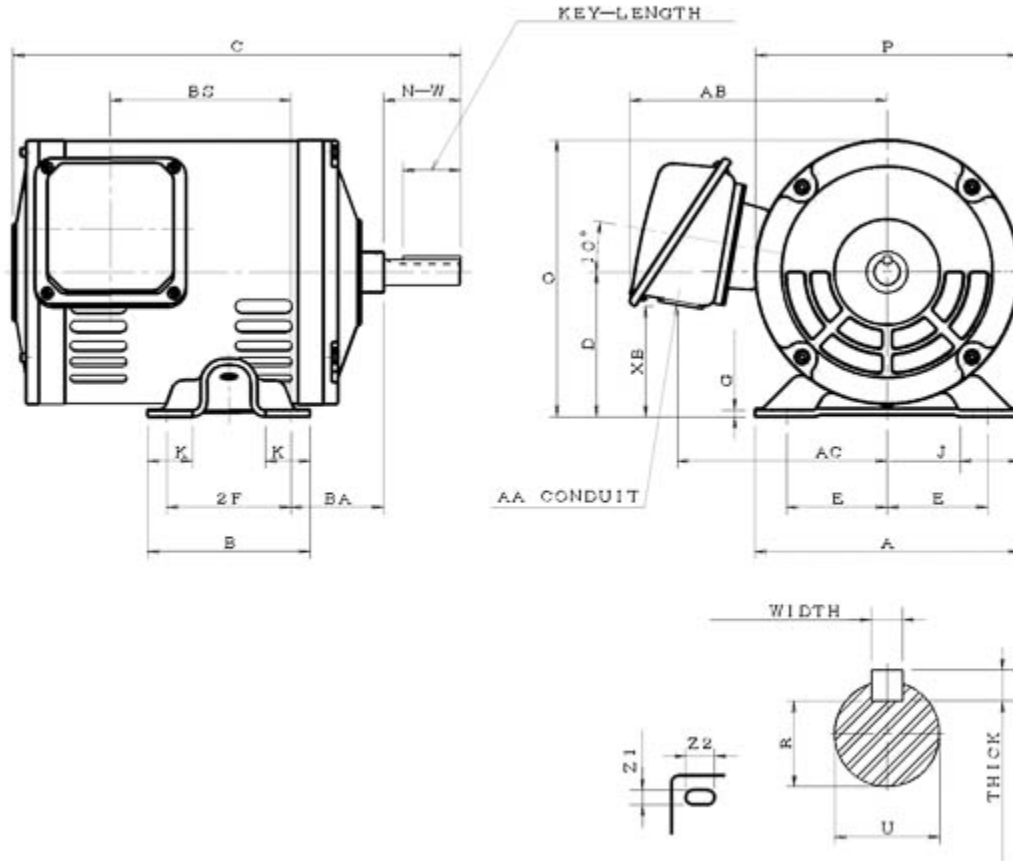

ASGH-SMP-2

Frame Size	Mounting					A	B	C	CD	D	
	E	2F	2F2	H	BA						
56	2.44	3		0.34x0.68	2.75	6.42	4.18	11.84		3.5	
G	J	K	L	M	O	P	T	Key			Keyseat
0.16	1.5	1.46			6.7	6.4		Width	Thick	Length	R
								0.188	0.188	1.41	0.517
Terminal Housing				Aux Box		C/D Flange					
AA	AB	AC	XB	AE	AX	BB	AH	AK	BD	AJ	BF
1.1	6.2	4.93	2.66								
Shaft Extension			Bearings		Approx. Weight Lbs	SPL dBA/3ft	Ins. Class	S.F.	Drive Method	Dimensions	
N-W	U	V	DE	NDE							
1.875	0.625								Direct Coupling / Belt Drive	Inches	

Technical Data Sheet

Motor Type: ASGH

Catalogue No: RD0032-56

Nameplate Information

HP	Pole	RPM	Frame	Voltage	Hz	Phase
3	2		56			
Enclosure	Ins. Class	Service Factor	Time Rating	NEMA Design	Rated Amb.	Rated Altitude
ODP					°C	

Typical Performance

Efficiency (%)				Power Factor (%)		
Full Load		3/4 Load	1/2 Load	Full Load	3/4 Load	1/2 Load
Nom.	Min.					
Torque				Current (A)		
Full Load (lb-ft)	Locked Rotor (% FLT)	Pull Up (% FLT)	Break Down (% FLT)	No Load	Full Load	Locked Rotor
NEMA KVA Code	Inertia (WR ²)			Safe Stall Time (s)		Noise Level Sound Press. dB(A)
	Rotor (lb-ft ²)	NEMA Load (lb-ft ²)	Max. Allowable (lb-ft ²)	Cold	Hot	

VFD Duty Information

Speed Range			VFD		S.F.
Constant Torque	Variable Torque	Constant Power	Carrier	Type	

Additional Information

Bearings		Approx. Weight
DE	NDE	lbs

Hazardous Locations Information

Temp Code (Sinewave / VFD)		/
----------------------------	--	---