

Dimensões em polegada
Dimensions in inches

THIS IS AN UPDATED REVISION, THE
PREVIOUS ONE MUST BE DISREGARDED.

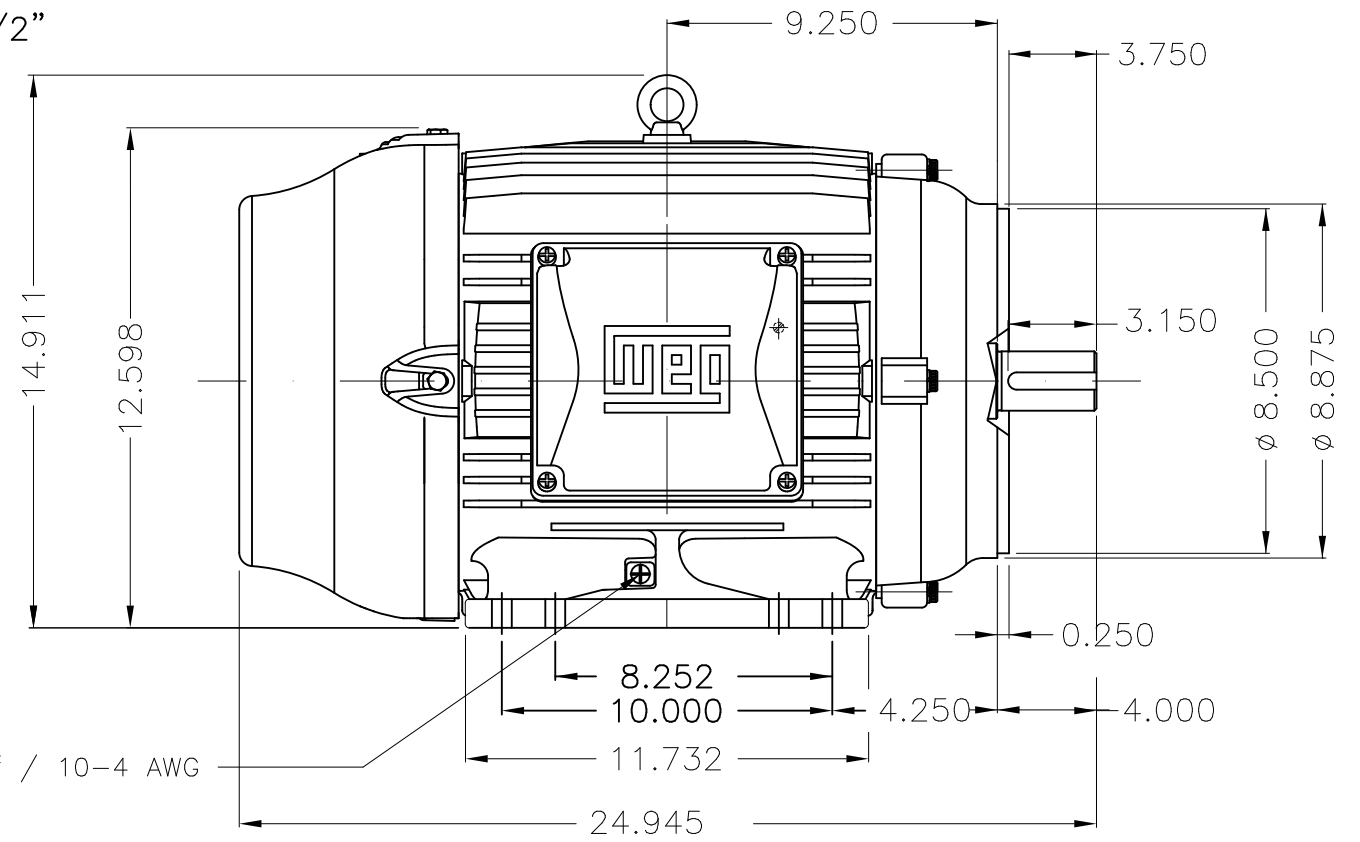

Grounding for leads 5.2–25 mm² / 10–4 AWG

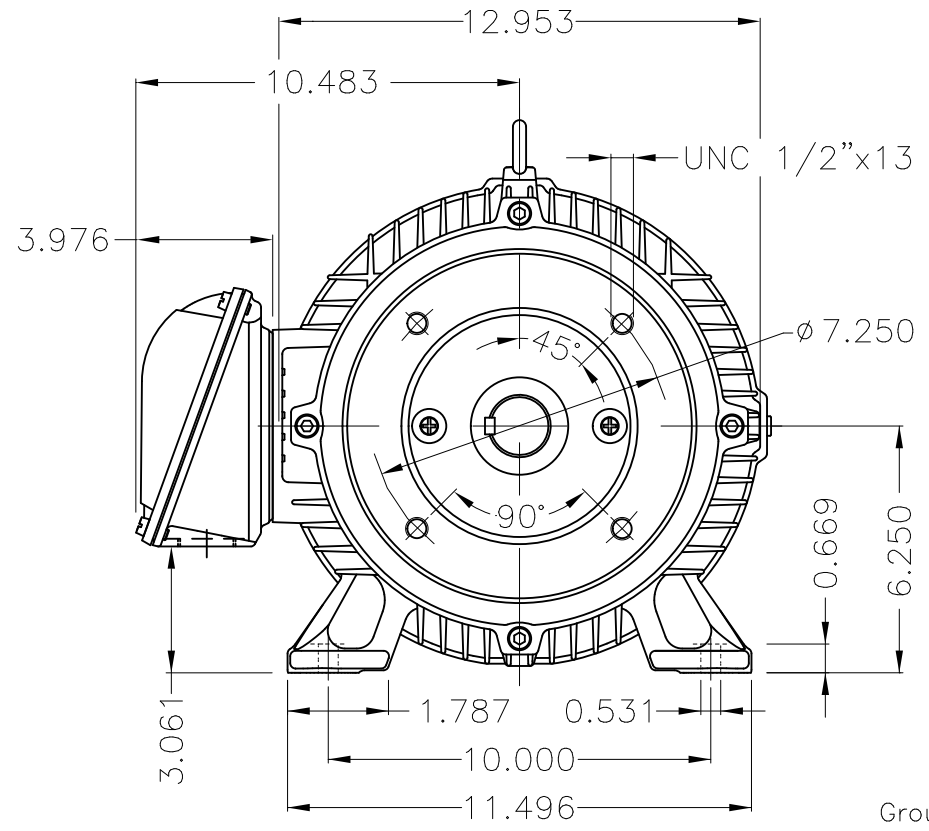

Grounding for leads 5.2–25 mm² / 10–4 AWG

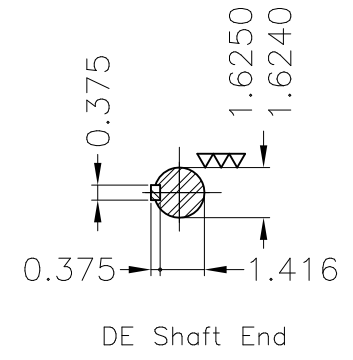

Color RAL 5009
Painting plan 202E
Mounting B34R(D)

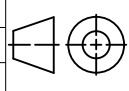
ECM	LOC	SUMMARY OF MODIFICATIONS			EXECUTED	CHECKED	RELEASED	DATE	VER
EXECUTED	USERADMIN	 THREE PH. W22 NEMA P.EFF MOTOR IEEE841 FRAME 254/6TC IP55 TEFC WEG code: 12385188							
CHECKED									
RELEASED									
REL DT	24.07.2017	WMO	Jaragua do Sul	Product Engineering	SHEET	1 / 1			

15 HP 02 Poles 60Hz

A

