

Dimensões em polegada
Dimensions in inches

THIS IS AN UPDATED REVISION, THE
PREVIOUS ONE MUST BE DISREGARDED.

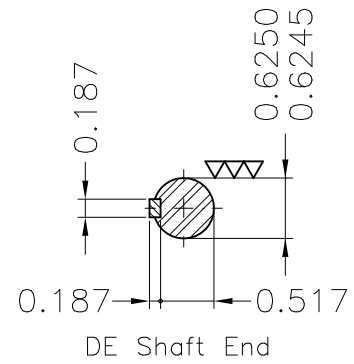
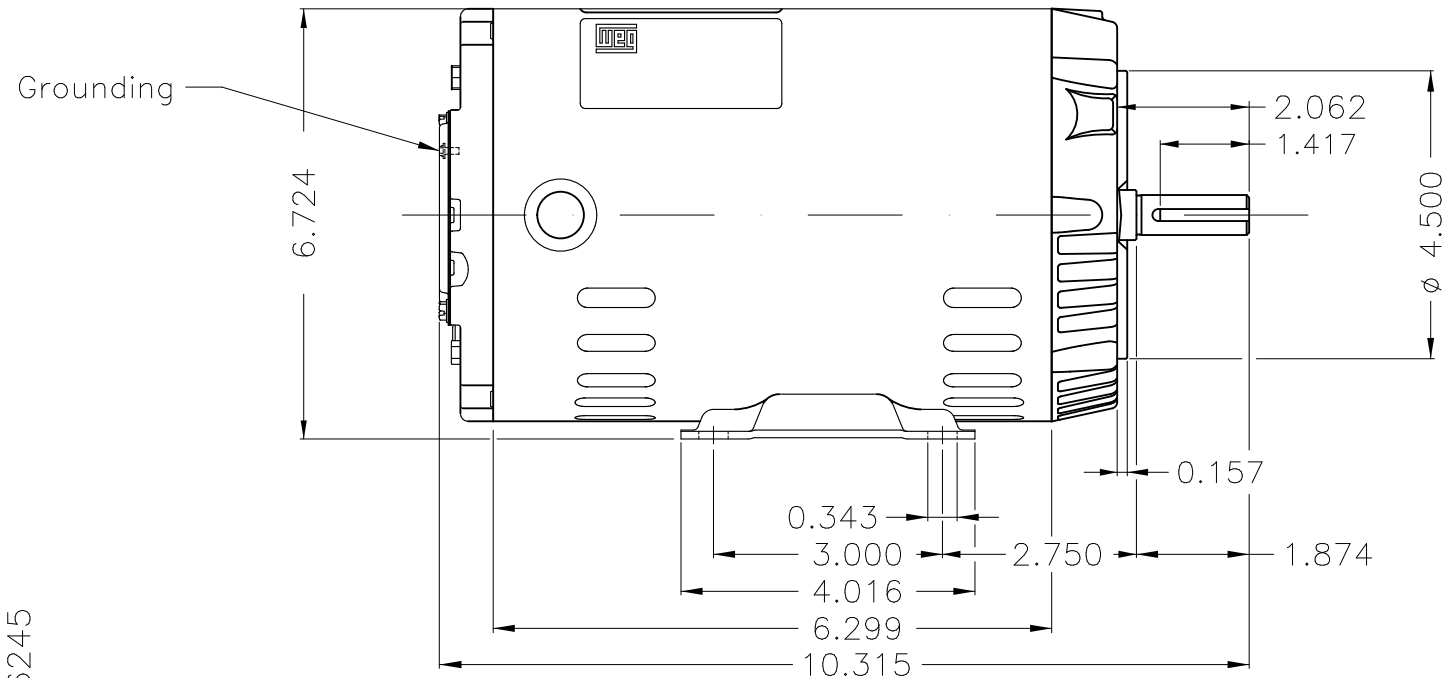
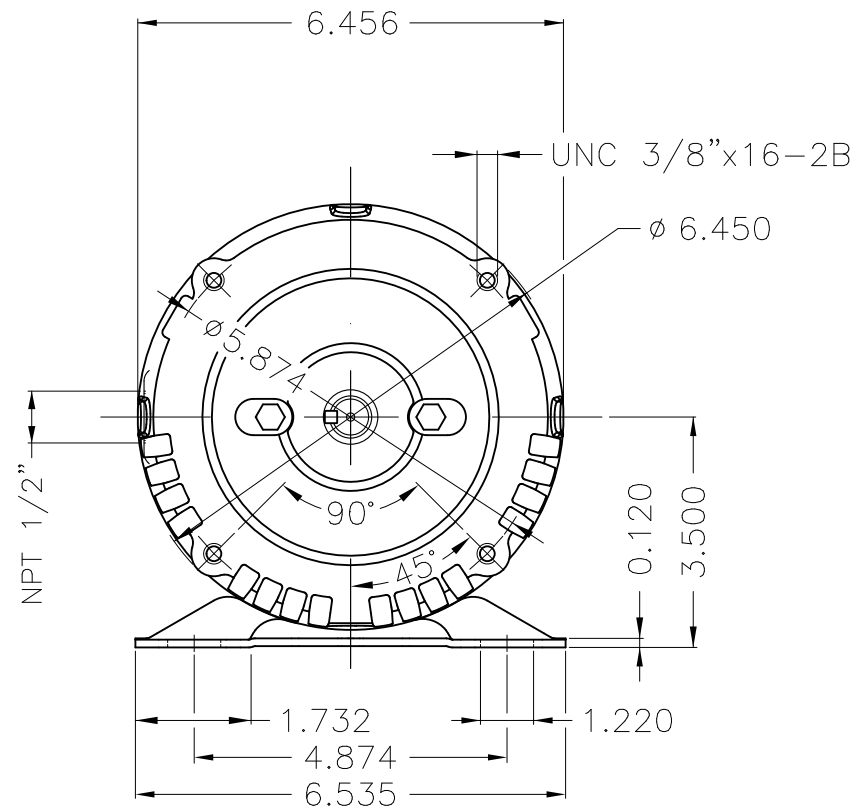

Without coating						
Mounting F-1/B34R(D)						
ECM	LOC	SUMMARY OF MODIFICATIONS		EXECUTED	CHECKED	RELEASED
EXECUTED	USERADMIN	THREE PHASE ODP ROLLED STEEL PREM. EFF.				
CHECKED		FRAME 56C ODP				
RELEASED		WEG code: 12808928				
REL DT	24.07.2017	WMO	Jaragua do Sul	Product Engineering	SHEET	1 / 1

0.25 HP 06 Poles 60Hz

A

