

Dimensões em polegada
Dimensions in inches

THIS IS AN UPDATED REVISION, THE
PREVIOUS ONE MUST BE DISREGARDED.

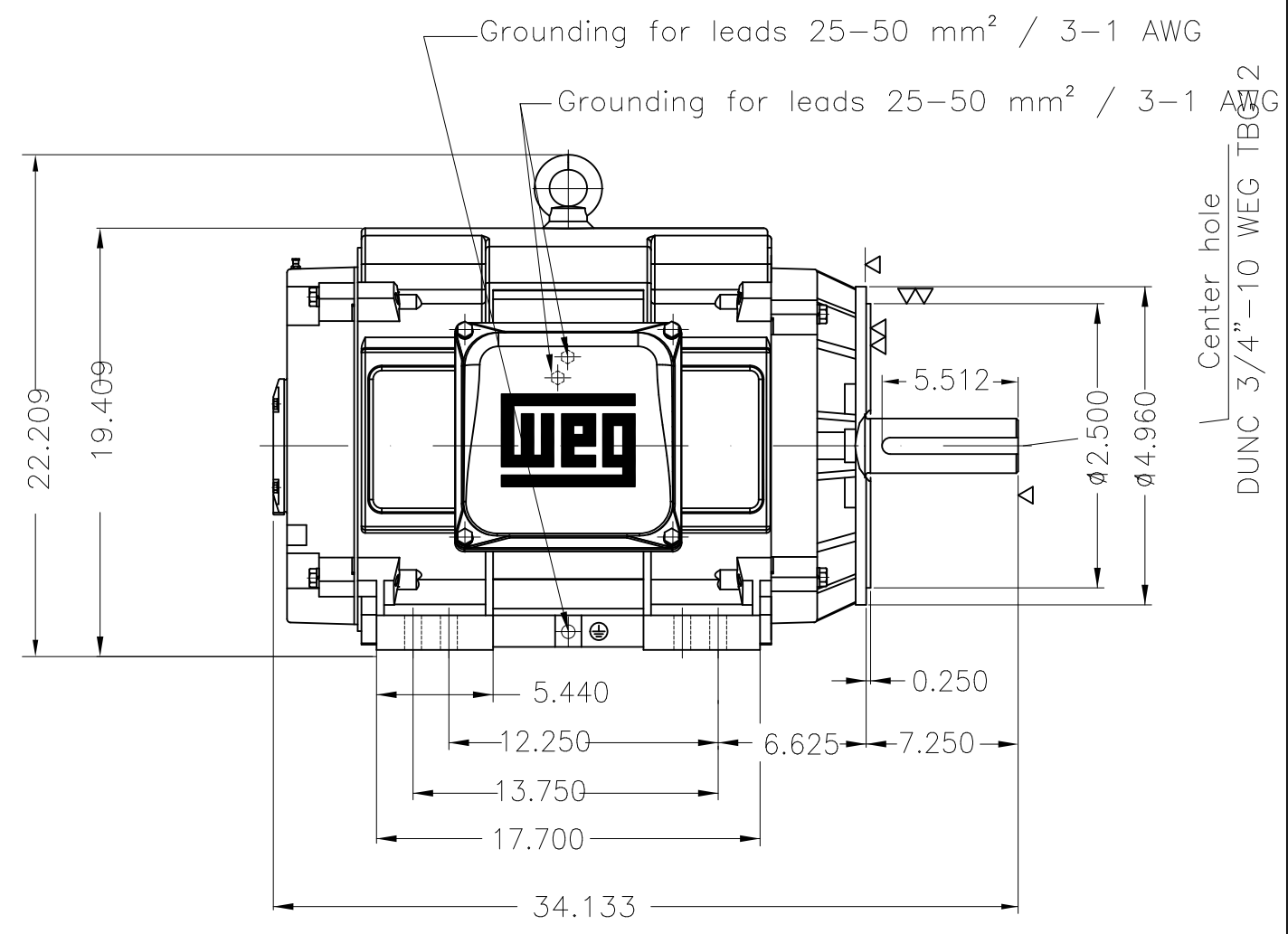
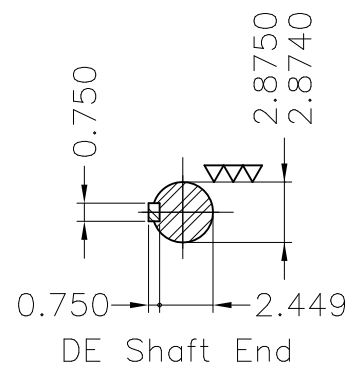
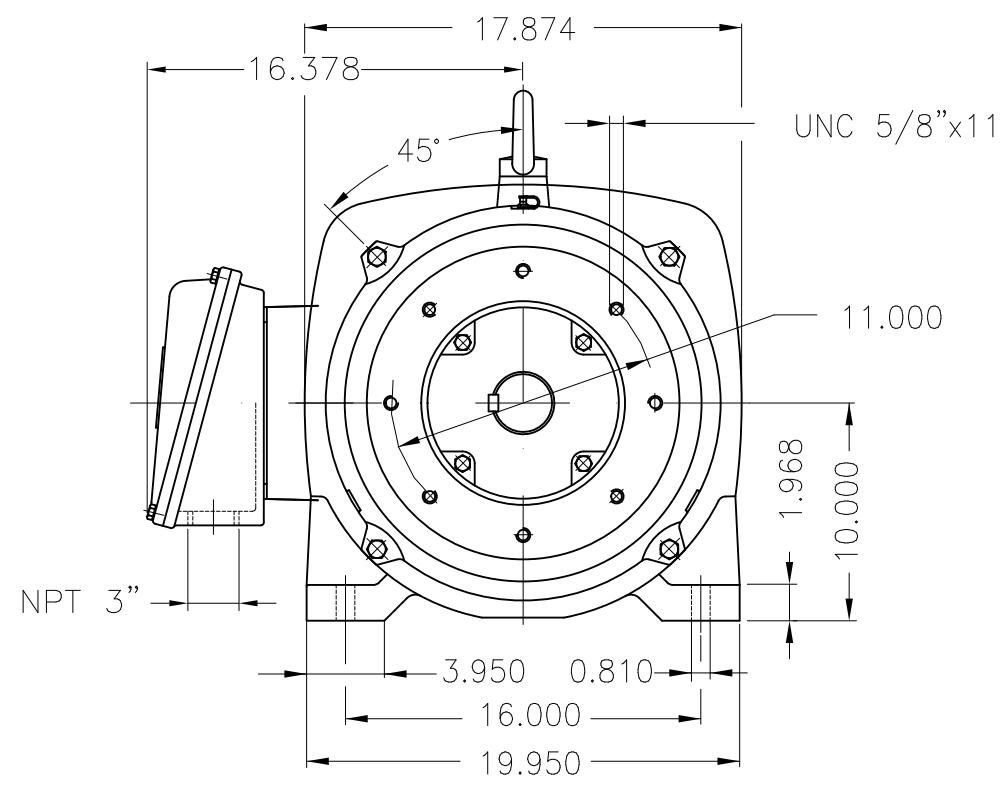

Certification UL/FIRE PUMP
Color RAL 3002
Painting plan 203A
Mounting B34R(D)

ECM	LOC	SUMMARY OF MODIFICATIONS			EXECUTED	CHECKED	RELEASED	DATE	VER
EXECUTED	USERADMIN		THREE PHASE MOTOR - HIGH EFFICIENCY						
CHECKED			FRAME 404/5TC IP23 ODP						
RELEASED			WEG code: 11980711						
REL DT	24.07.2017	WMO	Jaragua do Sul	Product Engineering	SHEET	1 / 1			

100 HP 04 Poles 60Hz

