

Dimensional Drawing

Catalogue	Model	HP	Pole	kW	Rating	Voltage	Hz	RPM
RD00345	ASGH	3	4	2.2	Continuous	575 V	60	1800

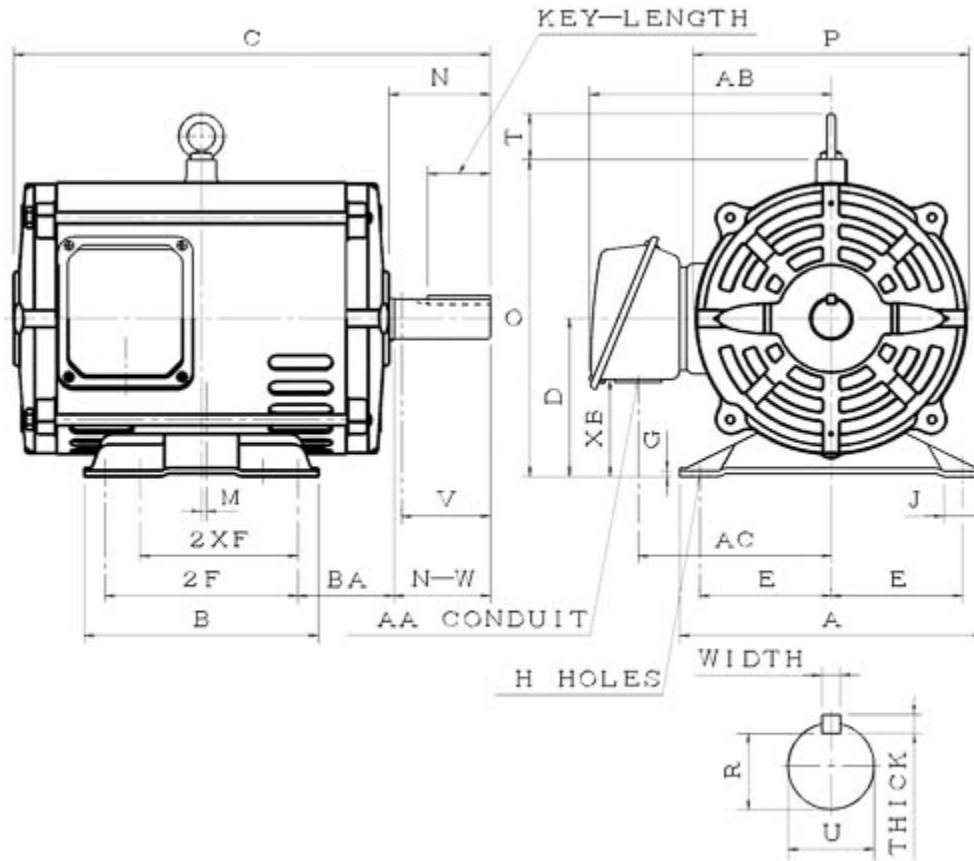

ASGH-SMP-4

Frame Size	Mounting					A	B	C	CD	D	
	E	2F	2F2	H	BA						
182T	7.5		4.5	0.41	2.75	8.66	6.68	14.39		4.5	
G	J	K	L	M	O	P	T	Key			Keyseat
0.16	1.22			0.394	8.99	7.73	1.31	Width	Thick	Length	R
								0.25	0.25	1.78	0.986
Terminal Housing				Aux Box		C/D Flange					
AA	AB	AC	XB	AE	AX	BB	AH	AK	BD	AJ	BF
1.1	6.9	5.51	2.77								
Shaft Extension			Bearings		Approx. Weight Lbs	SPL dBA/3ft	Ins. Class	S.F.	Drive Method	Dimensions	
N-W	U	V	DE	NDE							
2.75	1.125	2.7	6206ZZC3	6205ZZC3	60	57	F	1.15	Direct Coupling / Belt Drive	Inches	

Technical Data Sheet

Motor Type: ASGH

Catalogue No: RD00345

Nameplate Information

HP	Pole	RPM	Frame	Voltage	Hz	Phase
3	4	1755	182T	575	60	3
Enclosure	Ins. Class	Service Factor	Time Rating	NEMA Design	Rated Amb.	Rated Altitude
ODP	F	1.15	Continuous	B	-40 to 40 °C	<3300 ft

Typical Performance

Efficiency (%)				Power Factor (%)		
Full Load		3/4 Load	1/2 Load	Full Load	3/4 Load	1/2 Load
Nom.	Min.					
89.5	87.5	89.0	87.0	73.0	65.0	51.5
Torque				Current (A)		
Full Load (lb-ft)	Locked Rotor (% FLT)	Pull Up (% FLT)	Break Down (% FLT)	No Load	Full Load	Locked Rotor
8.98	215	190	310	2.1	3.4	26
NEMA KVA Code	Inertia (WR ²)			Safe Stall Time (s)		Noise Level Sound Press. dB(A)
	Rotor (lb-ft ²)	NEMA Load (lb-ft ²)	Max. Allowable (lb-ft ²)	Cold	Hot	
K	0.308	17	67	39	27	57

VFD Duty Information

Speed Range			VFD		S.F.
Constant Torque	Variable Torque	Constant Power	Carrier	Type	
6-60Hz	3-60Hz	60-120Hz	≤ 5 kHz	VPWM or CPWM	1.0 Only

Additional Information

Bearings		Approx. Weight
DE	NDE	lbs
6206ZZC3	6205ZZC3	60

Hazardous Locations Information

N/A	
0	
0	
Temp Code (Sinewave / VFD)	0 / 0