

Dimensional Drawing

Catalogue	Model	HP	Pole	kW	Rating	Voltage	Hz	RPM
RD0036	ASGH	3	6	2.2	Continuous	230 / 460 V	60	1200

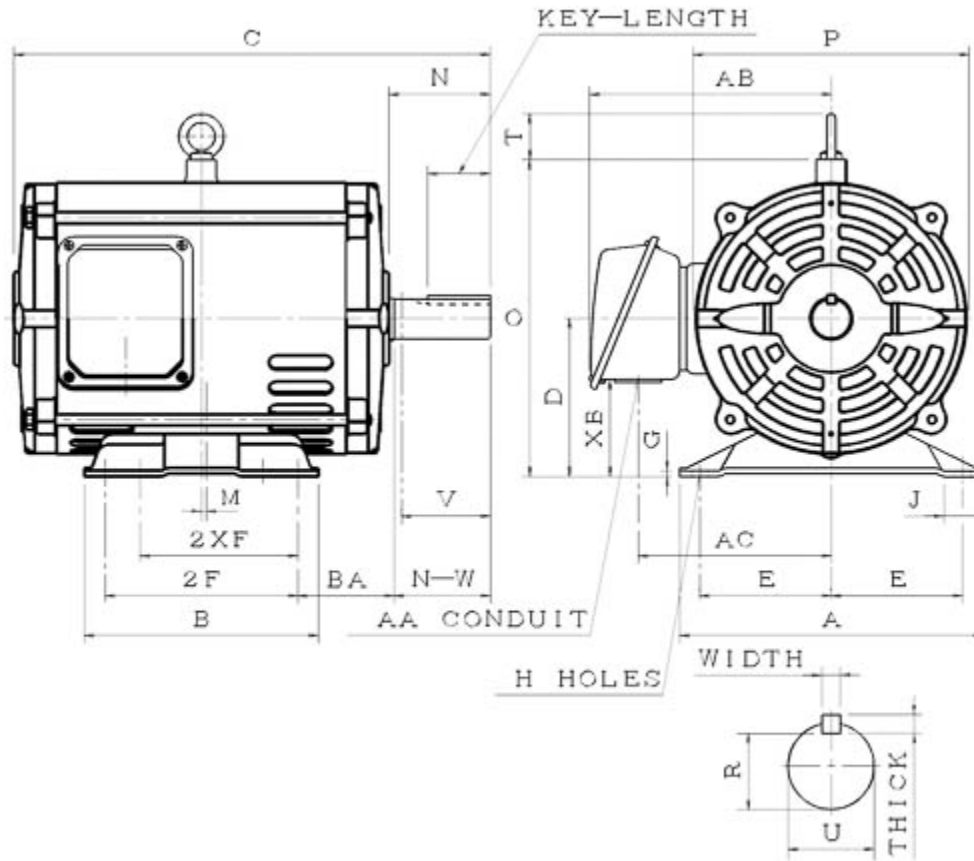

ASGH-SMP-4

Frame Size	Mounting					A	B	C	CD	D	
	E	2F	2F2	H	BA						
213T	8.5		5.5	0.41	3.5	9.7	8.2	18.09		5.25	
G	J	K	L	M	O	P	T	Key			Keyseat
0.18	1.22			0.45	10.53	8.98	1.63	Width	Thick	Length	R
								0.312	0.312	2.41	1.201
Terminal Housing				Aux Box		C/D Flange					
AA	AB	AC	XB	AE	AX	BB	AH	AK	BD	AJ	BF
1.38	8.16	6.38	2.81								
Shaft Extension			Bearings		Approx. Weight Lbs	SPL dBA/3ft	Ins. Class	S.F.	Drive Method	Dimensions	
N-W	U	V	DE	NDE							
3.38	1.375	3.3	6208ZZC3	6206ZZC3	95	53	F	1.15	Direct Coupling / Belt Drive	Inches	

Technical Data Sheet

Motor Type: ASGH

Catalogue No: RD0036

Nameplate Information

HP	Pole	RPM	Frame	Voltage	Hz	Phase
3	6	1175	213T	230 / 460	60	3
Enclosure	Ins. Class	Service Factor	Time Rating	NEMA Design	Rated Amb.	Rated Altitude
ODP	F	1.15	Continuous	B	-40 to 40 °C	<3300 ft

Typical Performance

Efficiency (%)				Power Factor (%)		
Full Load		3/4 Load	1/2 Load	Full Load	3/4 Load	1/2 Load
Nom.	Min.					
88.5	86.5	89.0	87.0	69.0	60.0	46.0
Torque				Current (A)		
Full Load (lb-ft)	Locked Rotor (% FLT)	Pull Up (% FLT)	Break Down (% FLT)	No Load	Full Load	Locked Rotor
13.41	185	165	315	6.0 / 3.0	9.2 / 4.6	64 / 32
NEMA KVA Code	Inertia (WR ²)			Safe Stall Time (s)		Noise Level Sound Press. dB(A)
	Rotor (lb-ft ²)	NEMA Load (lb-ft ²)	Max. Allowable (lb-ft ²)	Cold	Hot	
K	0.640	44	216	56	39	53

VFD Duty Information

Speed Range			VFD		S.F.
Constant Torque	Variable Torque	Constant Power	Carrier	Type	
6-60Hz	3-60Hz	60-120Hz	≤ 5 kHz	VPWM or CPWM	1.0 Only

Additional Information

Bearings		Approx. Weight
DE	NDE	lbs
6208ZZC3	6206ZZC3	95

Hazardous Locations Information

N/A	
Temp Code (Sinewave / VFD)	/