

CATALOG #	TYPE	FRAME	OUTPUT		POLE	SYN. SPEED R.P.M.	VOLTAGE V.	Hz.	TIME RATING	INSULATION CLASS	SERVICE FACTOR	WEIGHT LBS
			HP	KW								
WP0054C	AEGP	184TC	5	3.73	4	1800	230/460	60	CONT.	F	1.15	104 LBS.

TOTALLY ENCLOSED FAN-COOLED TYPE. SQUIRREL CAGE MOTOR

Ø.50 CABLE GLAND

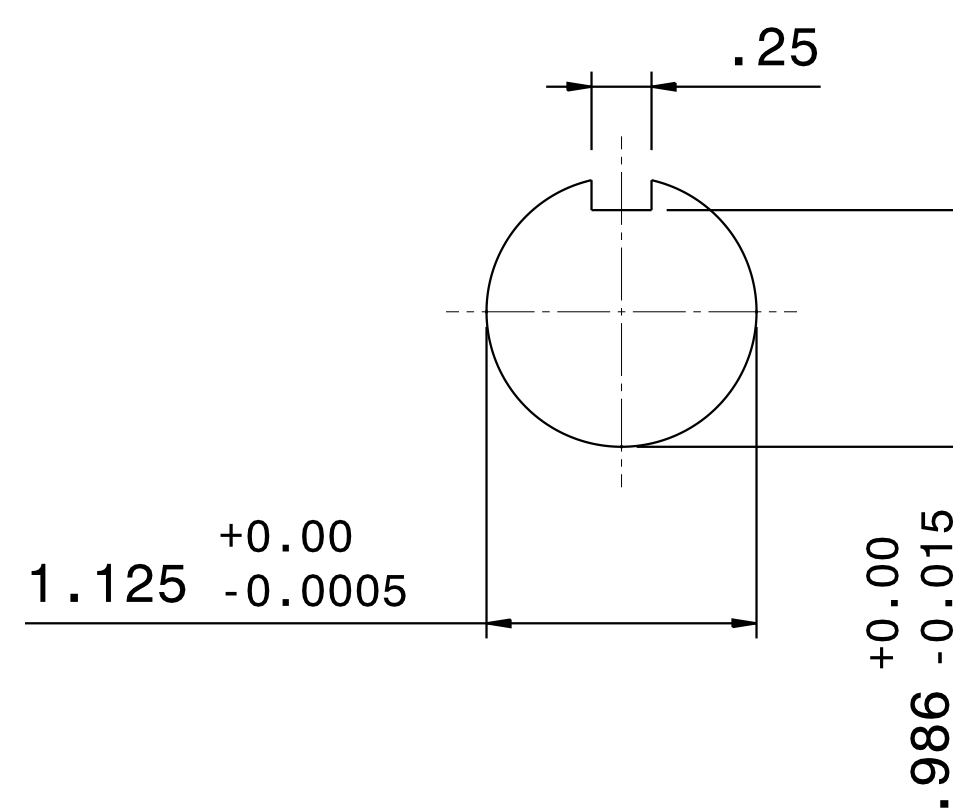
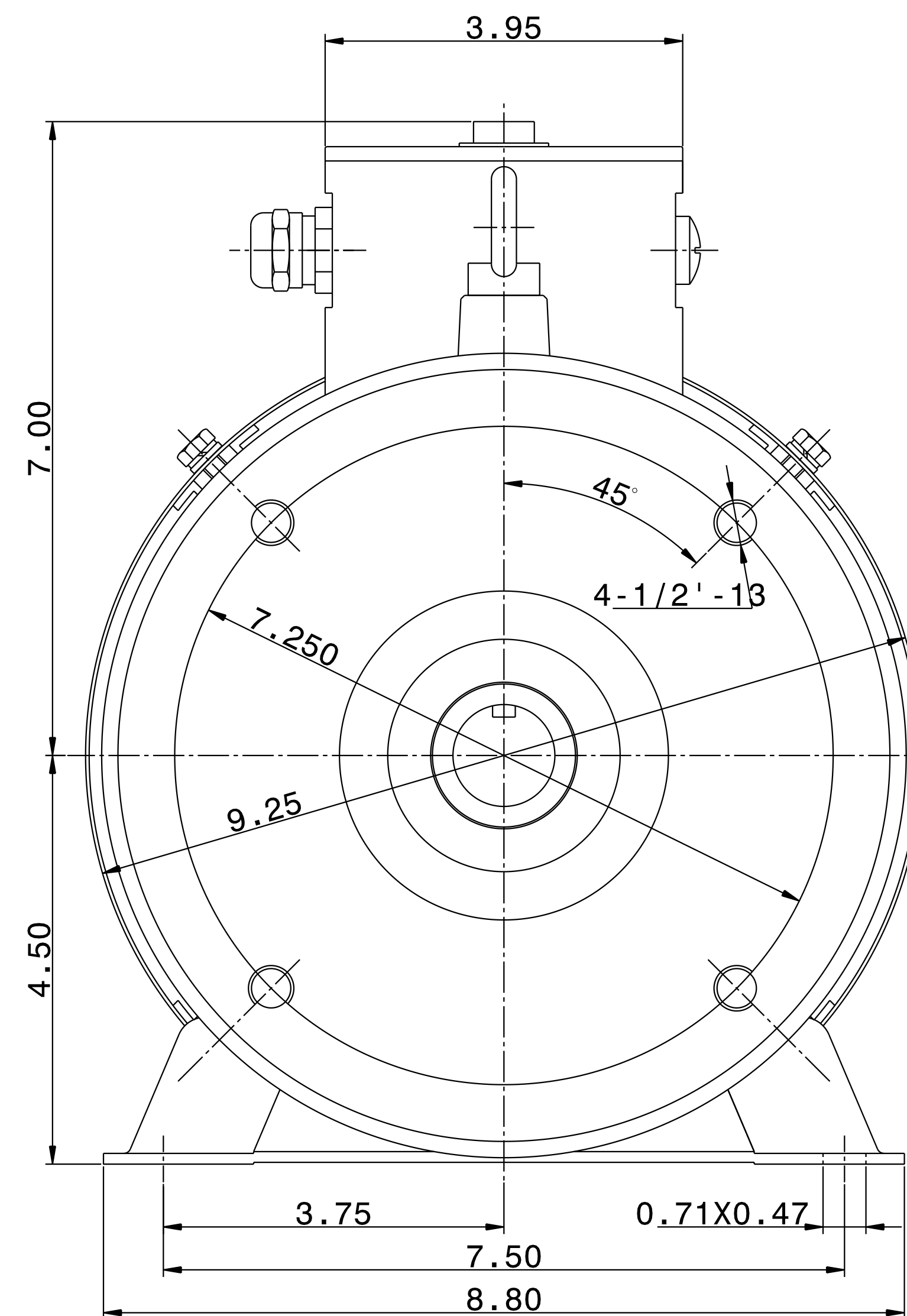
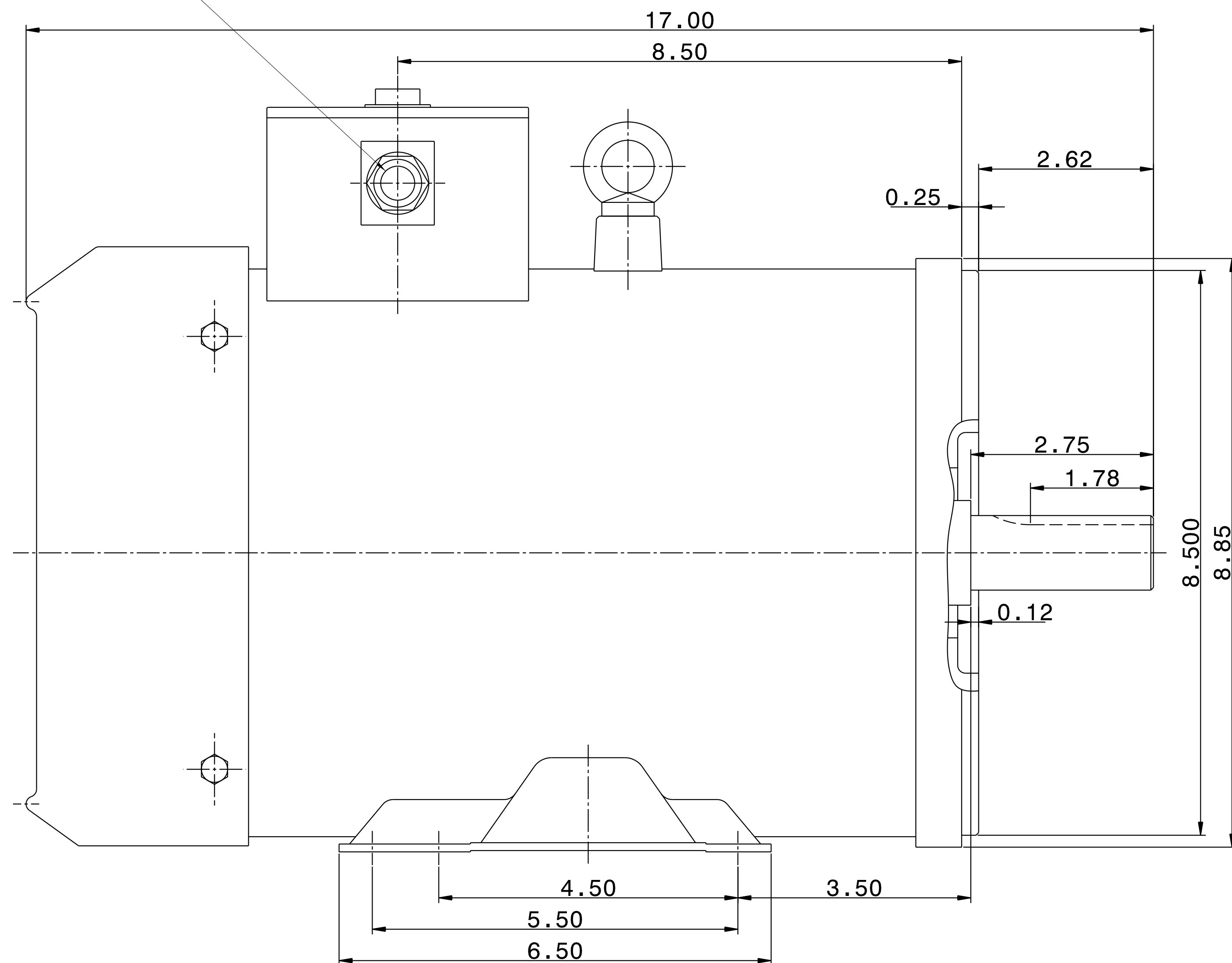

- NOTES: 1. DIMENSIONS IN INCH.
 2. ENCLOSURE: IP56.
 3. FOR DIRECT FLEXIBLE COUPLING.
 4. STAINLESS STEEL CONSTRUCTION.

REF: 31049J806230	REV. DATA		
	TECO Westinghouse		REV NO 01
	3-PHASE INDUCTION MOTOR OUTLINE DIMENSIONS		DWG NO. WP0054C
	DWN T. FELPS	020713	APPD S. GROHOSKY 020713
TECO-WESTINGHOUSE MOTOR COMPANY		ROUND ROCK, TEXAS	USA