

Dimensões em polegada
Dimensions in inches

THIS IS AN UPDATED REVISION, THE
PREVIOUS ONE MUST BE DISREGARDED.

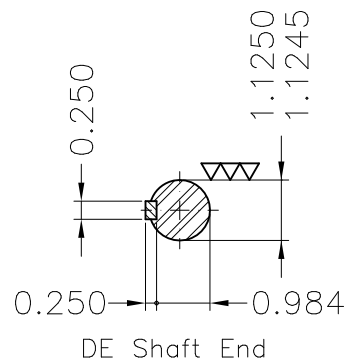
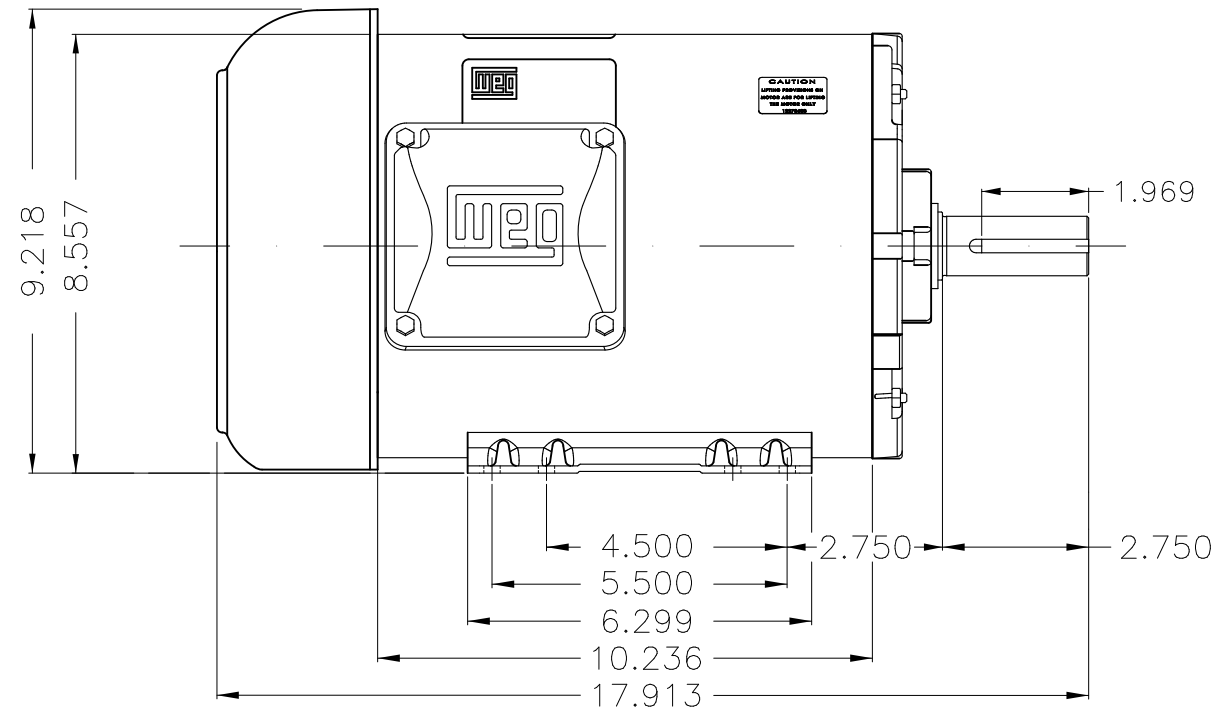
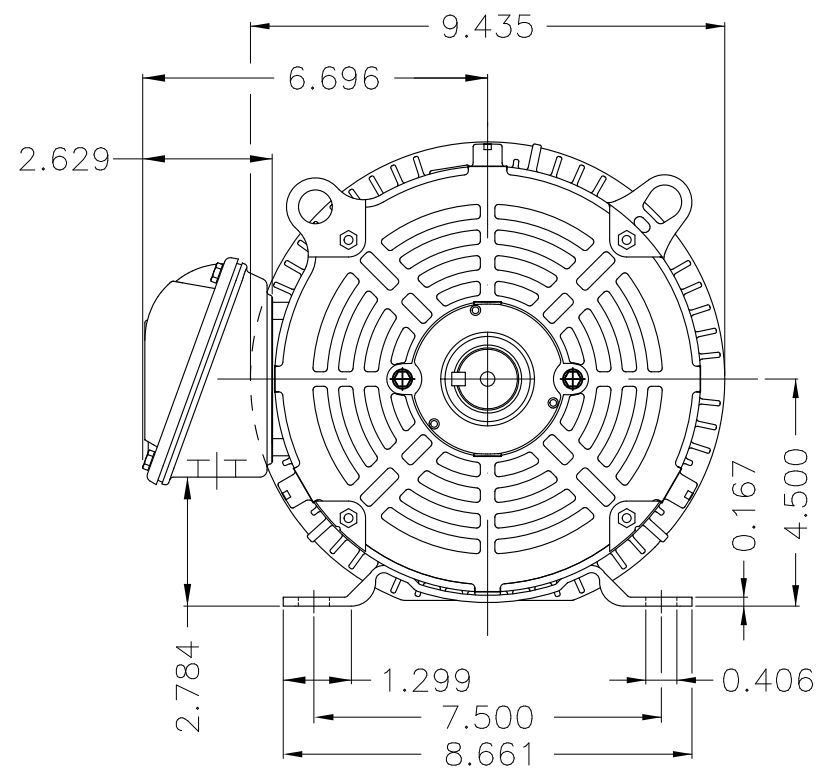
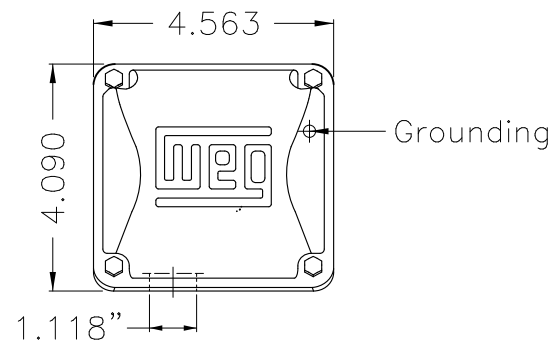

- Brush holder Kit AEGIS internal DE
- Bearing cap
- Color Munsell N 1 matte black
- Painting plan 207N
- Mounting F-1/B3R(D)

ECM	LOC	SUMMARY OF MODIFICATIONS			EXECUTED	CHECKED	RELEASED	DATE	VER
EXECUTED	USERADMIN		THREE P. MOTOR TEFC ROLLED STEEL NEMA P.						
CHECKED			FRAME 182/4T IP55 TEFC						
RELEASED			WEG code: 12674984						
REL DT	24.07.2017	WMO	Jaragua do Sul	Product Engineering	SHEET	1 / 1			

5 HP 04 Poles 60Hz

A

