

Dimensional Drawing

Catalogue	Model	HP	Pole	kW	Rating	Voltage	Hz	RPM
XH12545R	AEHHXU	125	4	93	Continuous	575 V	60	1800

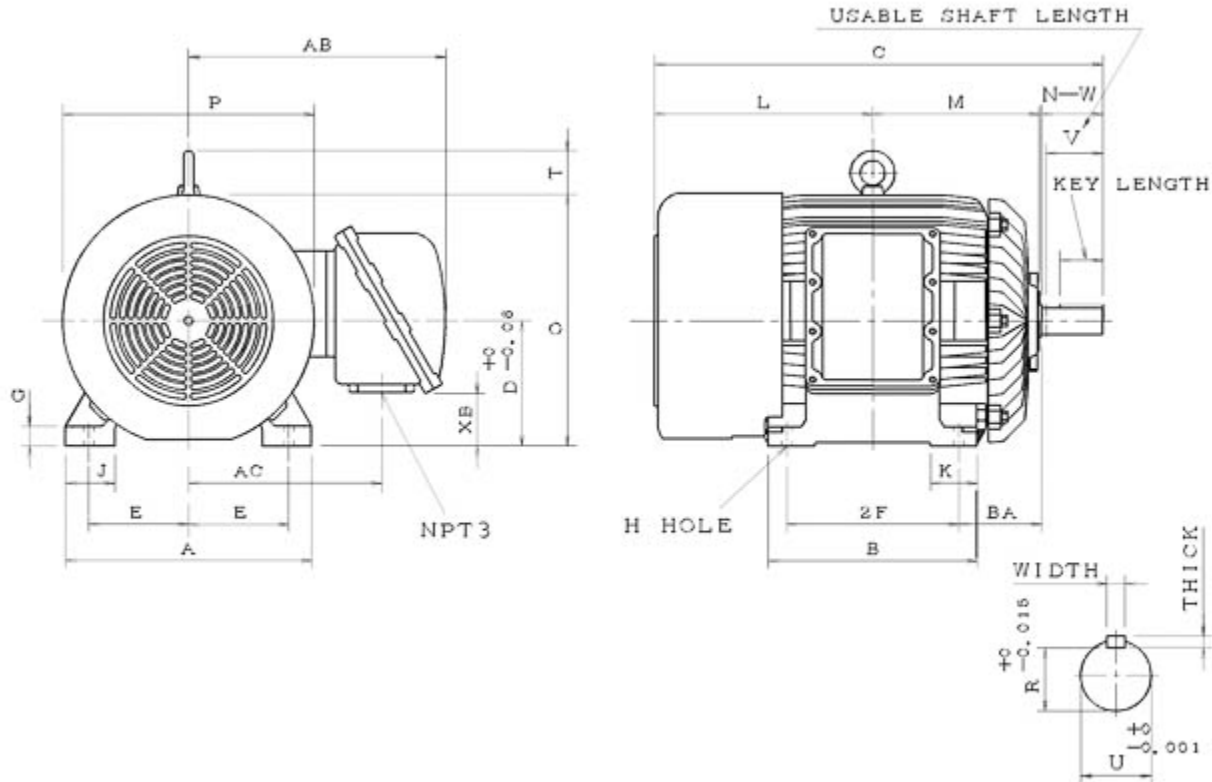

AEHHXU-HMP-2 1 0

Frame Size	Mounting					A	B	C	CD	D	
	E	2F	2F2	H	BA						
444T	9	14.5		0.81	7.5	22.05	17.5	42.05		11	
G	J	K	L	M	O	P	T	Key			Keyseat
1.55	4.35	4.35	18.8	14.45	22.25	23.3	3.55	Width	Thick	Length	R
								0.875	0.875	6.91	2.880
Terminal Housing				Aux Box		C/D Flange					
AA	AB	AC	XB	AE	AX	BB	AH	AK	BD	AJ	BF
NPT3"	21.65	16.6	5.1								
Shaft Extension			Bearings		Approx. Weight Lbs	SPL dBA/3ft	Ins. Class	S.F.	Drive Method	Dimensions	
N-W	U	V	DE	NDE							
8.5	3.375	8	NU318	6318	1600	83.0	F	1.15	Belt Drive	Inches	

Technical Data Sheet

Motor Type: AEHHXU

Catalogue No: XH12545R

Nameplate Information

HP	Pole	RPM	Frame	Voltage	Hz	Phase
125	4	1780	444T	575	60	3
Enclosure	Ins. Class	Service Factor	Time Rating	NEMA Design	Rated Amb.	Rated Altitude
TEXP	F	1.15	Continuous	B	-40 to 40 °C	<3300 ft

Typical Performance

Efficiency (%)				Power Factor (%)		
Full Load		3/4 Load	1/2 Load	Full Load	3/4 Load	1/2 Load
Nom.	Min.					
95.4	94.5	95.0	94.1	88.5	83.0	76.0
Torque				Current (A)		
Full Load (lb-ft)	Locked Rotor (% FLT)	Pull Up (% FLT)	Break Down (% FLT)	No Load	Full Load	Locked Rotor
368.7	120.0	96.0	210.0	30.3	110.9	726
NEMA KVA Code	Inertia (WR ²)			Safe Stall Time (s)		Noise Level Sound Press. dB(A)
	Rotor (lb-ft ²)	NEMA Load (lb-ft ²)	Max. Allowable (lb-ft ²)	Cold	Hot	
G	45.0	542.0	1015.0	34.0	12.0	83.0

VFD Duty Information

Speed Range			VFD		S.F.
Constant Torque	Variable Torque	Constant Power	Carrier	Type	
6-60Hz	3-60Hz	60-90Hz	≤ 5 kHz	VPWM or CPWM	1.0 Only

Additional Information

Bearings		Approx. Weight
DE	NDE	lbs
NU318	6318	1600

Hazardous Locations Information

CSA/UL Certified	
Class I, Div 1, Groups D; Class II, Div 1, Groups E, F & G Class I, Zone 1, Groups IIA; Class II, Div 1, Groups E, F & G	
Temp Code (Sinewave / VFD)	T3B / T3B