

# Product Information Packet

January 12, 2017

Data shown is for the current revision model #. Ensure your nameplate model # matches.

<b>Model Number:</b>	<b>5KS511XAA159B</b>
<b>Catalog Number:</b>	<b>Q8123</b>
<b>Instruction Manual:</b>	GEI-56128
<b>Connection Diagram:</b>	GEM2034E-FIG20
<b>Outline Drawing:</b>	239C6B00JY

Accessory Connection Diagrams			
<b>Bearing Thermocouple:</b>	None	<b>Heater:</b>	3027JE-1
<b>RTD:</b>	235A3027WN	<b>Thermistor:</b>	None
<b>Thermostat:</b>	None	<b>Winding Thermocouple:</b>	None
<b>Bearing RTD:</b>	235A3027NA		

Table of Contents	
Specification	01
Performance Characteristics	02
Outline Drawing	03
Connection Drawing(s)	04

**Marks:**

<b>MODEL NUMBER:</b>	<b>5KS511XAA159B</b>	<b>Estimated Weight:</b>	5393 Lbs
<b>Outline Drawing:</b>	239C6B00JY	<b>Time Rating:</b>	CONT
<b>Connection Diagram:</b>	GEM2034E-FIG20	<b>Enclosure:</b>	TEFC
<b>Instruction Book:</b>	GEI-56128	<b>Encl Construction:</b>	841
<b>Design Code:</b>	50BD0171A	<b>Ambient Max(°C):</b>	40
<b>Type:</b>	KS	<b>Alt Ambient Max(°C):</b>	--
<b>Frame:</b>	5011LS	<b>Insulation Class:</b>	F
<b>Phases:</b>	3	<b>NEMA Design:</b>	B
<b>Poles:</b>	2	<b>Nominal Efficiency:</b>	95.8 %
<b>Output Power:</b>	450HP 333KW	<b>Guaranteed Efficiency:</b>	95.0
<b>RPM:</b>	3570	<b>3/4 Load Efficiency:</b>	96.0
<b>Voltage:</b>	460	<b>KVA Code:</b>	G
<b>Hertz:</b>	60	<b>Max KVAR:</b>	49.4
<b>Amps - FL:</b>	468.0	<b>Power Factor:</b>	94.0
<b>Service Factor:</b>	1.15	<b>Bearing - DE:</b>	6315ZC3
<b>Alt Service Factor:</b>	--	<b>Bearing - ODE:</b>	6315ZC3

**Enclosure is Totally Enclosed Fan-Cooled**

**Stamped Nameplate Notes:**

EXCEPTION TO IEEE-STD-841-2009: SOUND POWER 94 DBA  
TSTAT HTR LDS H 115V 200W  
DE BRG 75BC03XP3, ODE BRG 75BC03XP3  
ROT CW FACING ODE LEAD/PH SEQUENCE 1-2-3/1-2-3  
INVERTER DUTY PER NEMA MG1 PART 31  
ALTERNATE RATING FOR PWM CONTROL:1.0SF 40C AMBIENT  
VAR TORQUE RANGE 0-60 HZ  
MAXIMUM EXPOSED INTERNAL AND EXTERNAL SURFACE  
TEMPERATURES DO NOT EXCEED 200C UNDER USUAL  
SERVICE CONDITIONS AT 1.0SF  
MAXIMUM SPACE HEATER SURFACE TEMPERATURE FOR  
NORMAL OPERATION AT RATED CONDITIONS 160C  
STAMP NP249A5499AP AS BELOW:  
MODEL:5KS511XAA159B S/N: XXX  
EX NA IIC T3 GC CSA.09.2216219  
CLASS I, ZONE 2, AEX NA IIC T3  
CLASS I, DIV 2, GROUPS A, B, C, D T3  
-25C <= TAMB <= 40C  
FOR DIRECT COUPLED LOAD ONLY

**Additional Information:**

2P - LS EXTN - SPLIT LEAD  
PAINTED FRAME ID & SHAFT, FAN COVER INSIDE &  
ODE E/S OUTSIDE  
CW ROTATION FACING OPPOSITE DRIVE END  
2500 CU IN - 2(4.00" NPT)  
C/B GRD PLATE

INPRO SEAL BOTH ENDS  
OIL RESISTANT SLEEVING ON LEADS  
.0015" TIR SHAFT RUNOUT  
ROUTINE TEST REPORT AND 5 POINT VIBRATION TEST  
REPORT INCLUDED IN C/B  
COPPER WASHER UNDER HEADS OF BEARING CAP BOLTS,  
APPLY TITE-SEAL (A50CD427A) ON BEARING CAP SCREWS,  
RABBETS AND PLUG THREADS.  
100 OHM WINDING RTD LEADS TO AUX C/BOX OPP MAIN C/BOX  
SUGGESTED WINDING RTD SETTINGS  
ALARM 165C TRIP 175C  
115V TSTAT CTRLD HTR LDS TO AUX BOX OPP MAIN CONDUIT BOX  
SPACE HEATER CAUTION NAMEPLATE  
BEARING RTD 100 OHM ON BOTH ENDS  
SUGGESTED BEARING RTD SETTINGS  
ALARM 115C TRIP 125C  
NEMA TYPE GRD PAD  
F1 MOUNTING

**Performance Characteristics**

1st Winding 1st Connection

**Design: 50BD0171A**

Marks:

LOAD %	125.0	115.0	100.0	75.0	50.0	25.0	0.0
% EFF	95.33	95.54	96	96.04	95.79	93.82	0.00
% PF	93.66	93.96	94.23	94.06	92.19	82.76	8.35
AMPS	589.63	539.58	464.93	349.69	238.46	135.61	68.67

TORQ(FL)#FT	662.01	TORQ(LR)%FL	87.38	TORQ(BD)%FL	274.65
AMPS(LR)	2969.37	PF AT START	0.15		

This motor is capable of two cold or one hot start with a maximum connected load inertia of 1069 Lb-Ft Sq (45 Kg-meter Sq)at 100% voltage, where the load torque varies with the square of the speed. Acceleration time with maximum inertia and the above load type is 32 seconds. Safe stall time at 100% voltage is 62 seconds cold, 38 seconds hot. Rotor inertia is 108.15 Lb-Ft Sq (4.55 Kg-meter Sq).

Open Circuit A-C:	2.112	Short Circuit D-C:	0.043
Short Circuit A-C:	0.052	X/R Ratio:	16.148
Stator Slots:	48	Rotor Slots:	40

**Speed Torque Current Curve (First Connection, First Speed)**

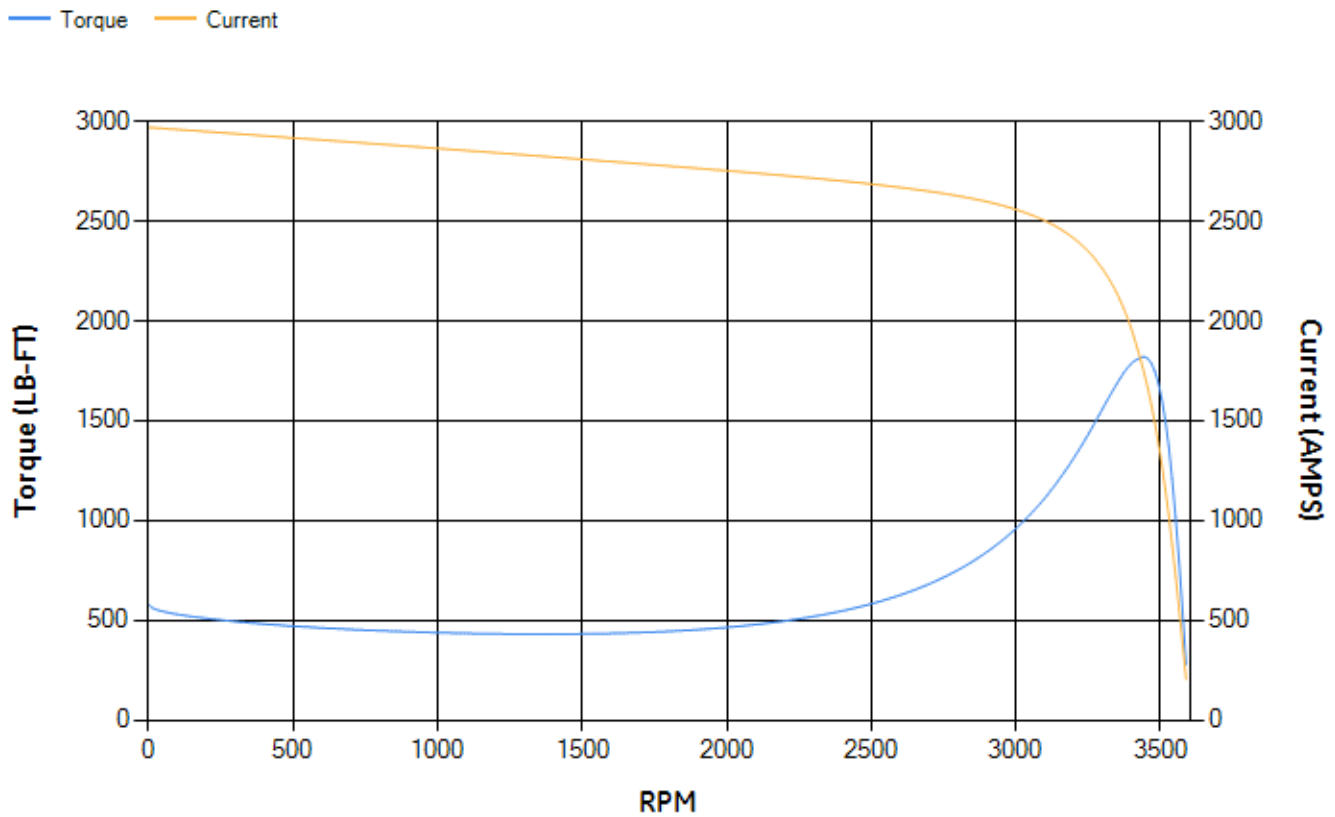

Marks:

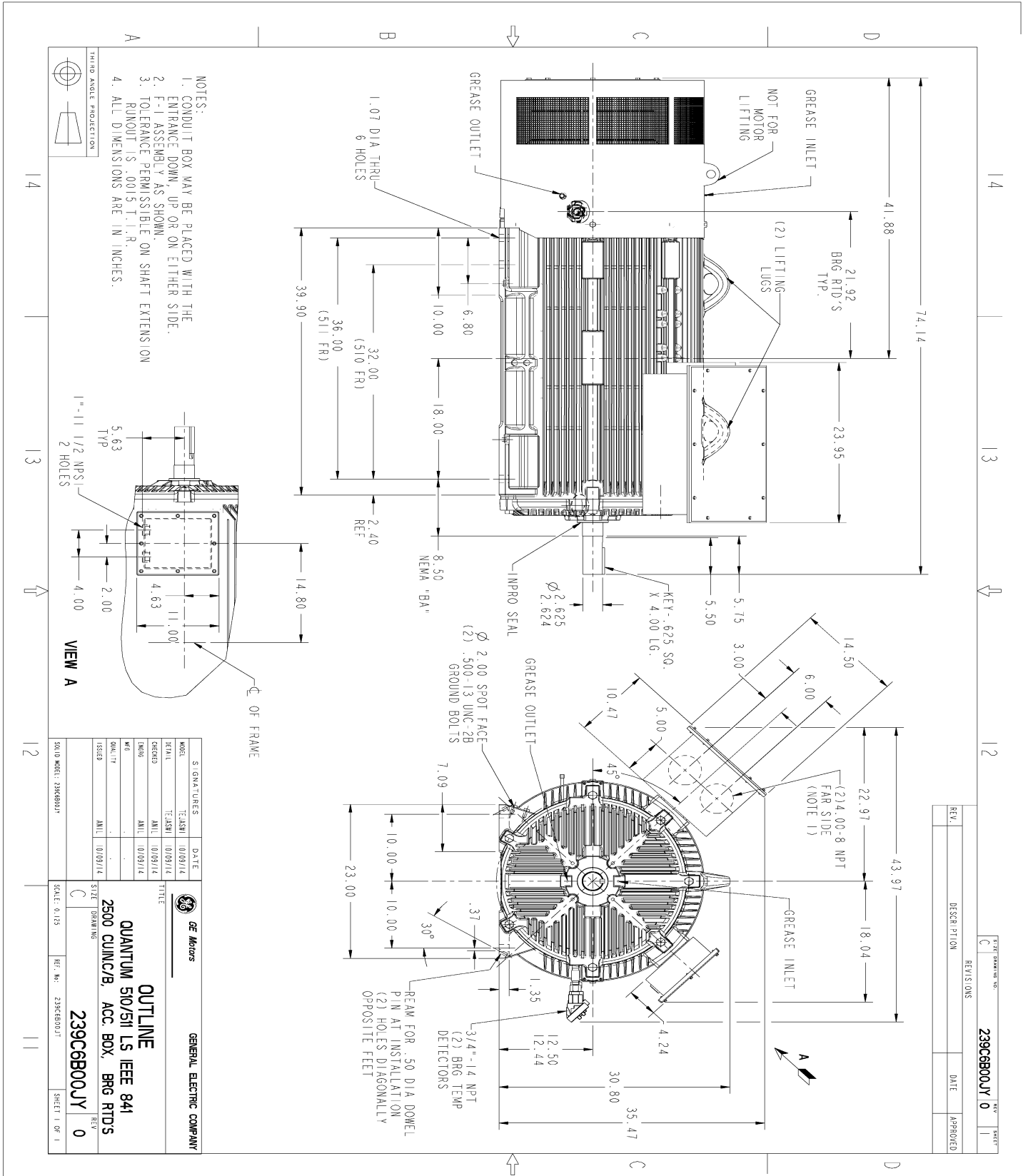

REV.	DESCRIPTION	DATE	APPROVED

SIGNATURES		DATE	
DESIGN	TECHNICAL		
DRAWING			

**GENERAL ELECTRIC COMPANY**  
**OUTLINE**  
**QUANTUM 510/511 LS IEEE 841**  
**2500 CUINC/B, ACC. BOX, BRG RTD'S**  
**239C6B00JY**  
 SCALE: 0.125 REF. NO.: 239C6B00J SHEET 1 OF 1

Marks:

**Connection Diagram**  
**GEM2034E-FIG20**

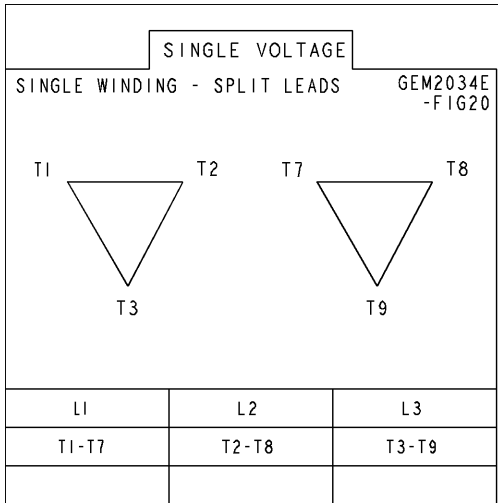

**Heater Connection**

3027JE-1

FIG. 1  
HEATER CONN.

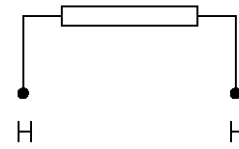

CONTROL	L1	L2
VOLTAGE ONLY	H	H

SHEET

REV

235A3027WN

SIZE DRAWING NO. A

GE PROPRIETARY INFORMATION

This document is the property of General Electric Company ("GE") and contains proprietary information of GE. This document is loaned on the express condition that neither it nor the information contained therein shall be disclosed to others without the express written consent of GE Industrial Systems, and that the information shall be used by the recipient only as approved expressly by GE Industrial Systems. This document shall be returned to GE upon its request. This document may be subject to certain restrictions under U.S. export control laws and regulations.

REVISIONS

REV.	DESCRIPTION	DATE	APPROVED

THIRD ANGLE PROJECTION

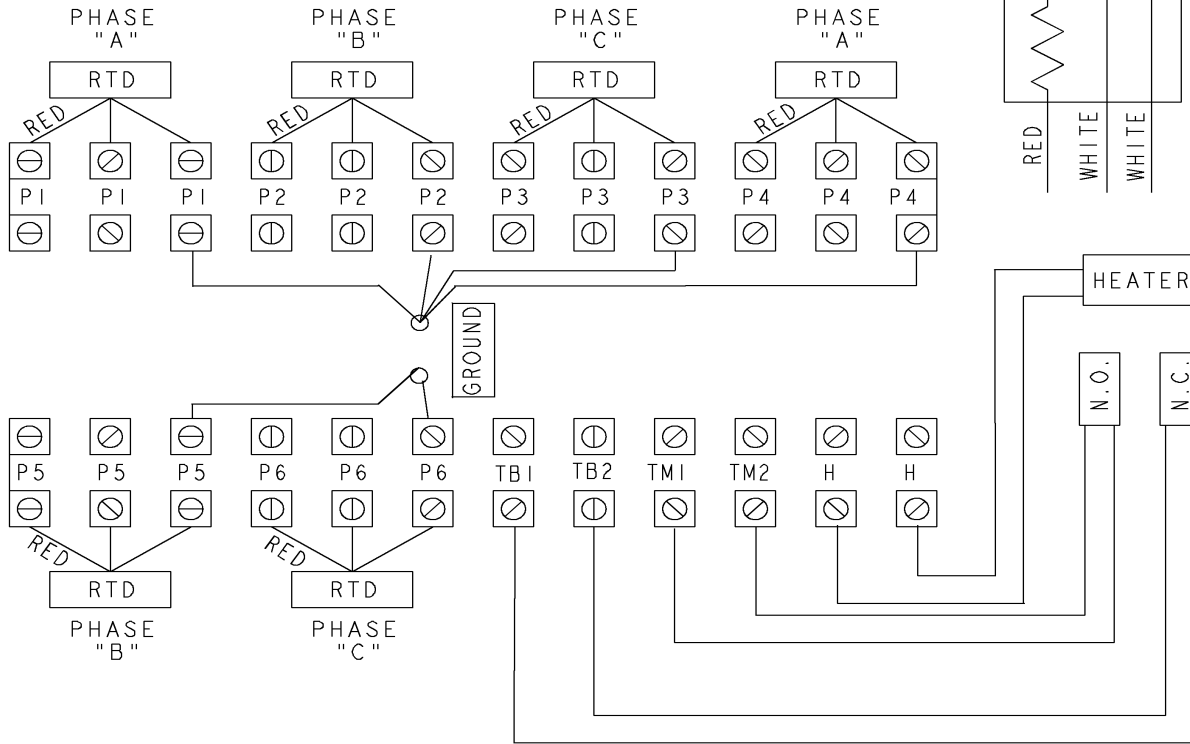
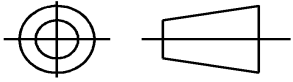

- NOTE 1: TERMINAL LABELS ARE PROVIDED FOR ACCESSORIES THAT MAY OR MAY NOT BE INCLUDED WITH THE MOTOR.
- NOTE 2: SPARE RTDS (P7 & P8) FURNISHED IN CASE OF FAILURE IN OTHER RTDS (P1-P6). PHASE LOCATION WILL DEPEND UPON NUMBER OF POLES WINDING CONFIGURATION.
- NOTE 3: IT IS RECOMMENDED THAT RTDS BE GROUNDED AT EITHER THE MACHINE OR CONNECTED TO A GROUNDED CONTROL CIRCUIT. FOR PROPER OPERATION DO NOT GROUND AT THE MACHINE IF CONNECTED TO A GROUND CIRCUIT AT THE CONTROL.

Part must conform to SI 900000 Sect. 4, Toxicity Procedure

FOR ADDITIONAL INFO REFER TO:	SIGNATURES	DATE
APPLIED PRACTICES	MODEL	
DIMENSIONS ARE IN INCHES	DETAIL VIVEK	07/19/13
TOLERANCE ON:	CHECKED VIJAY	07/19/13
1 PL DECIMALS ± 0.1	ENGRG	
2 PL DECIMALS ± 0.02	MFG	
3 PL DECIMALS ± 0.005	QUALITY	
ANGLES ± 0.5	ISSUED VIVEK	07/19/13
FRACTIONS ±		
FINISH ✓		
MATERIAL	SOLID MODEL: MODEL NAME	

**GE Motors** GENERAL ELECTRIC COMPANY

TITLE: **CONNECTION DIAGRAM**

**WINDING RTD'S & T'STATS & HEATERS**

SIZE DRAWING: **A**      **235A3027WN**      REV **0**

SCALE: NA      SHEET 1 of 1



REV   1 SH   SIZE   A DWG NO   235A3027NA	THIRD ANGLE PROJECTION		REVISIONS			
			REV	DESCRIPTION	DATE	APPROVED
	1	ISAAC #12-1124	HARI	11/19/12	KARTHIK	

**CONFIDENTIAL AND PROPRIETARY**

This document is the property of General Electric Company and contains proprietary and confidential information of the Motor Business Group (MBG). The document is loaned on the express conditions that neither it nor the information contained therein shall be disclosed to others without the express consent of MBG and that the information shall be used by the recipient only as approved expressly by MBG. Also, the document shall be returned to MBG upon its request.

# BEARING RTDS

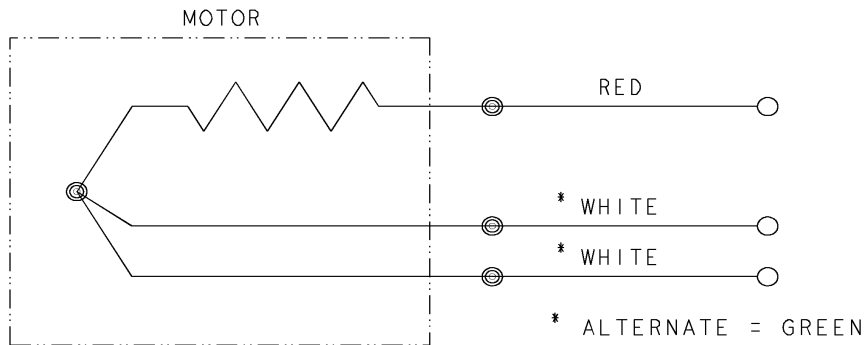

UNLESS OTHERWISE SPECIFIED DIMENSIONS ARE IN INCHES TOLERANCES ON: 2 PL DECIMALS ± 3 PL DECIMALS ± ANGLES ± FRACTIONS ± MATERIAL: APPLIED PRACTICES:	SIGNATURES	DATE	Fort Wayne, Indiana <h2>CONNECTION DIAGRAM</h2>		
	DRAWN D.E. BAIR	12/16/92			
	CHECKED D.E. BAIR	12/16/92	SIZE	FSCM NO	DWG NO
	ENGRG K. DESAI	12/16/92	A		235A3027NA
	ISSUED D.E. BAIR	12/16/92	SCALE	1 / 1	SHEET 1 OF 1

DISTR TO

