

**Dimensional Drawing**

Catalogue	Model	HP	Pole	kW	Rating	Voltage	Hz	RPM
PDH03045C	AEHH8N	30	4	22	Continuous	575 V	60	1800

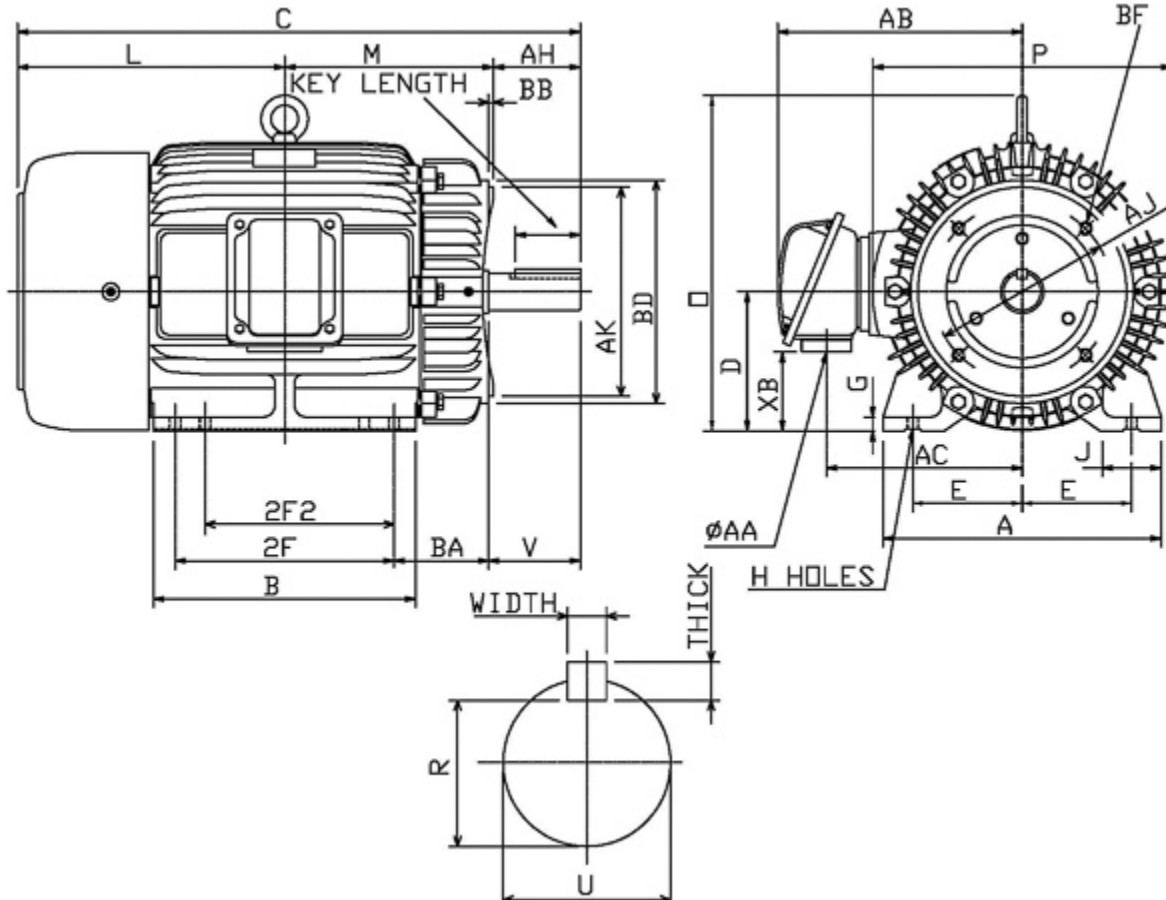

Frame Size	Mounting					A	B	C	CD	D
	E	2F	2F2	H	BA					
286TC	5.5	11	9.5	0.53	4.75	14	13.2	28.3		7

G	J	K	L	M	O	P	T	Key			Keyseat R
								Width	Thick	Length	
0.7	2.95		13.43	9.98	14.52	15.04	1.97	0.5	0.5	3.28	1.591

Terminal Housing				Aux Box		C/D Flange					
AA	AB	AC	XB	AE	AX	BB	AH	AK	BD	AJ	BF
1.25 NPT	12.28	9.84	3.97			0.25	4.37	10.5	11.22	9	1/2-13UNC

Shaft Extension			Bearings		Approx. Weight Lbs	SPL dBA/3ft	Ins. Class	S.F.	Drive Method	Dimensions
N-W	U	V	DE	NDE						
4.62	1.875	4.5	6311ZZ	6310ZZ	517	70	F	1.15	Direct Coupling / Belt Drive	Inches

### Technical Data Sheet

Motor Type: AEHH8N

Catalogue No: PDH03045C

#### Nameplate Information

HP	Pole	RPM	Frame	Voltage	Hz	Phase
30	4	1765	286TC	575	60	3
Enclosure	Ins. Class	Service Factor	Time Rating	NEMA Design	Rated Amb.	Rated Altitude
TEFC	F	1.15	Continuous	B	-40 to 40 °C	<3300 ft

#### Typical Performance

Efficiency (%)				Power Factor (%)		
Full Load		3/4 Load	1/2 Load	Full Load	3/4 Load	1/2 Load
Nom.	Min.					
93.6	92.4	93.6	93.6	87.5	85.5	79.5
Torque				Current (A)		
Full Load (lb-ft)	Locked Rotor (% FLT)	Pull Up (% FLT)	Break Down (% FLT)	No Load	Full Load	Locked Rotor
88.99	200	160	235	7.0	27.4	174
NEMA KVA Code	Inertia (WR <sup>2</sup> )			Safe Stall Time (s)		Noise Level Sound Press. dB(A)
	Rotor (lb-ft <sup>2</sup> )	NEMA Load (lb-ft <sup>2</sup> )	Max. Allowable (lb-ft <sup>2</sup> )	Cold	Hot	
G	5.274	144.0	328.0	25	18	70

#### VFD Duty Information

Speed Range			VFD		S.F.
Constant Torque	Variable Torque	Constant Power	Carrier	Type	
6-60Hz	3-60Hz	60-90Hz	≤ 5 kHz	VPWM or CPWM	

#### Additional Information

Bearings		Approx. Weight
DE	NDE	lbs
6311ZZ	6310ZZ	517

#### Hazardous Locations Information

CSA Certified	
Class I, Div 2, Groups B, C & D	
Class I, Zone 2, Groups IIB+H2, IIB & IIA	
Temp Code (Sinewave / VFD)	T3C / T3B