

Dimensões em polegada
Dimensions in inches

THIS IS AN UPDATED REVISION, THE
PREVIOUS ONE MUST BE DISREGARDED.

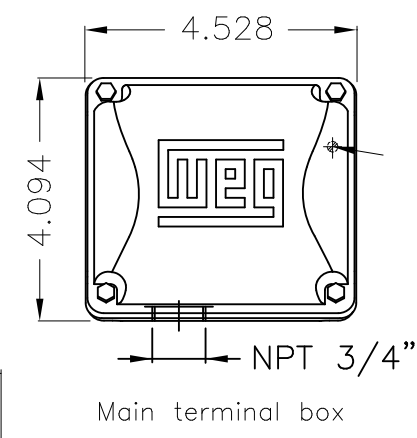

Grounding for leads 0.5–6 mm² / 20–10 AWG

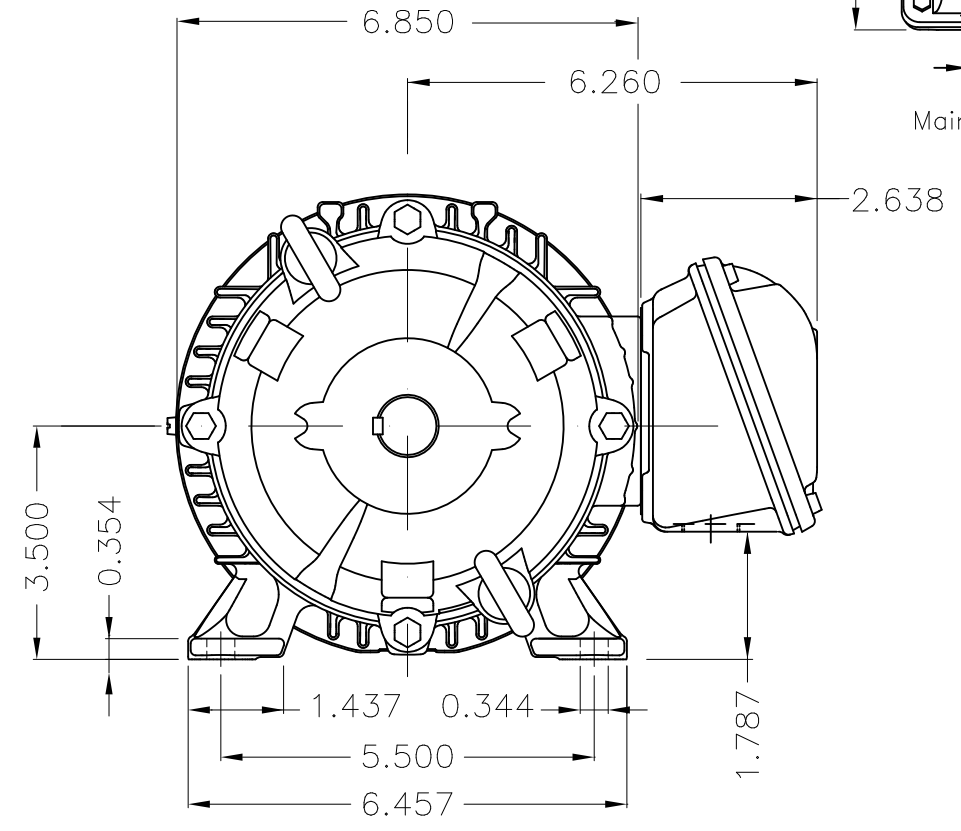
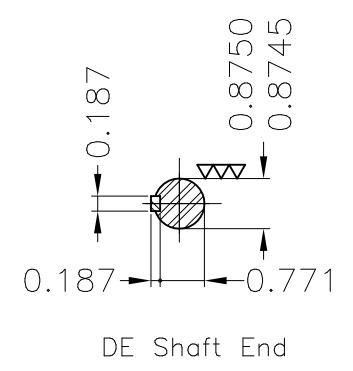
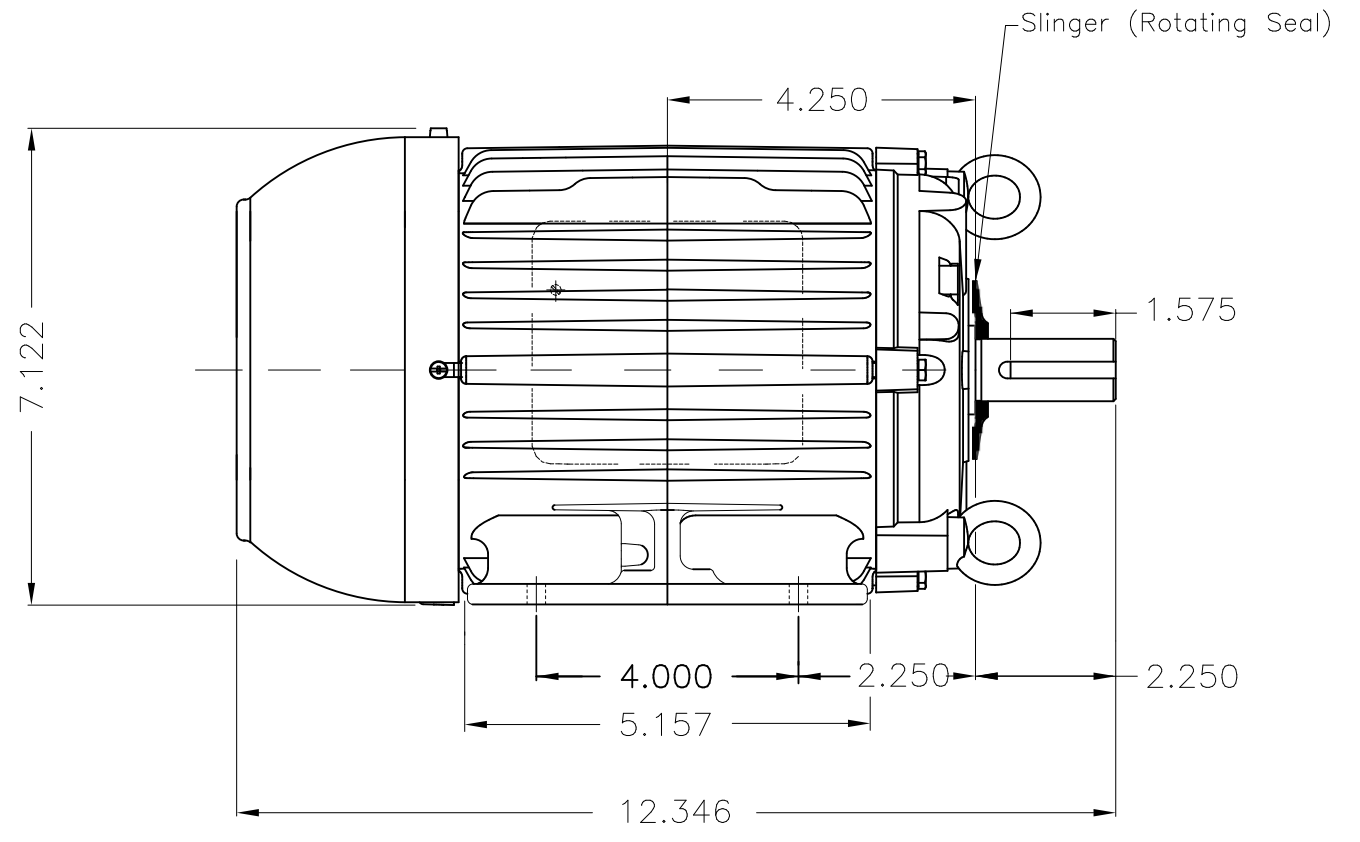

Color RAL 5009
Painting plan 202E
Mounting B3L(E)

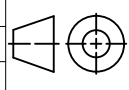
ECM	LOC	SUMMARY OF MODIFICATIONS	EXECUTED	CHECKED	RELEASED	DATE	VER
EXECUTED	USERADMIN	 THREE PH W22 MOTOR COOLING TOWER NEMA EF FRAME 143T IP55 TEFC WEG code: 11999439					
CHECKED							
RELEASED							
REL DT	24.07.2017	WMO Jaragua do Sul	Product Engineering	SHEET	1 / 1		

1 HP 04 Poles 60Hz

