

Dimensional Drawing

Catalogue	Model	HP	Pole	kW	Rating	Voltage	Hz	RPM
PDH60085R	AEHE	600	8	448	Continuous	575 V	60	900

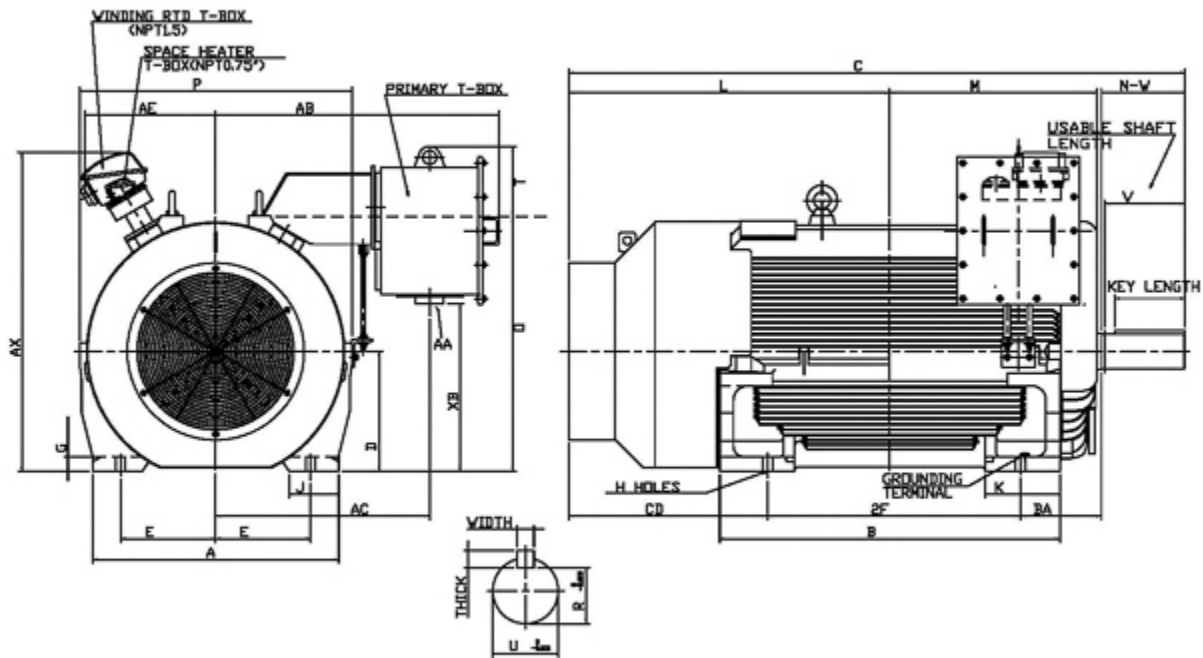

Frame Size	Mounting					A	B	C	CD	D	
	E	2F	2F2	H	BA						
6808C	13.5	36		1.38	11.5	35	48.45	87.28	28.29	17	
G	J	K	L	M	O	P	T	Key			Keyseat
								Width	Thick	Length	R
2	7.1	10.65	45.9	28.7	35.7	38.8	9.6	1.25	1.25	10	4.169
Terminal Housing			Aux Box			C/D Flange					
AA	AB	AC	XB	AE	AX	BB	AH	AK	BD	AJ	BF
2x 3 NPT	31.8	25.7	25.9	18.62	39.08						
Shaft Extension			Bearings		Approx. Weight Lbs	SPL dBA/3ft	Ins. Class	S.F.	Drive Method	Dimensions	
N-W	U	V	DE	NDE							
11.88	4.875	11.38	NU326C3	6322	8272	80	F	1.15	Belt Drive	Inches	

Technical Data Sheet

Motor Type: AEHE

Catalogue No: PDH60085R

Nameplate Information

HP	Pole	RPM	Frame	Voltage	Hz	Phase
600	8	892	6808C	575	60	3
Enclosure	Ins. Class	Service Factor	Time Rating	NEMA Design	Rated Amb.	Rated Altitude
TEFC	F	1.15	Continuous	B	-40 to 40 °C	<3300 ft

Typical Performance

Efficiency (%)				Power Factor (%)		
Full Load		3/4 Load	1/2 Load	Full Load	3/4 Load	1/2 Load
Nom.	Min.					
95.5	94.6	95.3	94.8	84.0	80.0	73.0
Torque				Current (A)		
Full Load (lb-ft)	Locked Rotor (% FLT)	Pull Up (% FLT)	Break Down (% FLT)	No Load	Full Load	Locked Rotor
3531.39	90	90	200	188.8	560.3	3784
NEMA KVA Code	Inertia (WR ²)			Safe Stall Time (s)		Noise Level Sound Press. dB(A)
	Rotor (lb-ft ²)	NEMA Load (lb-ft ²)	Max. Allowable (lb-ft ²)	Cold	Hot	
0	1147.000	12250.0	24500.0	24	18	80

VFD Duty Information

Speed Range			VFD		S.F.
Constant Torque	Variable Torque	Constant Power	Carrier	Type	
20-60Hz	3-60Hz	60-60Hz	≤ 5 kHz	VPWM or CPWM	

Additional Information

Bearings		Approx. Weight
DE	NDE	lbs
NU326C3	6322	8272

Hazardous Locations Information

N/A	
N/A	
N/A	
Temp Code (Sinewave / VFD)	T3 / T3