

**Dimensional Drawing**

Catalogue	Model	HP	Pole	kW	Rating	Voltage	Hz	RPM
RD0204	ASGH	20	4	15	Continuous	230 / 460 V	60	1800

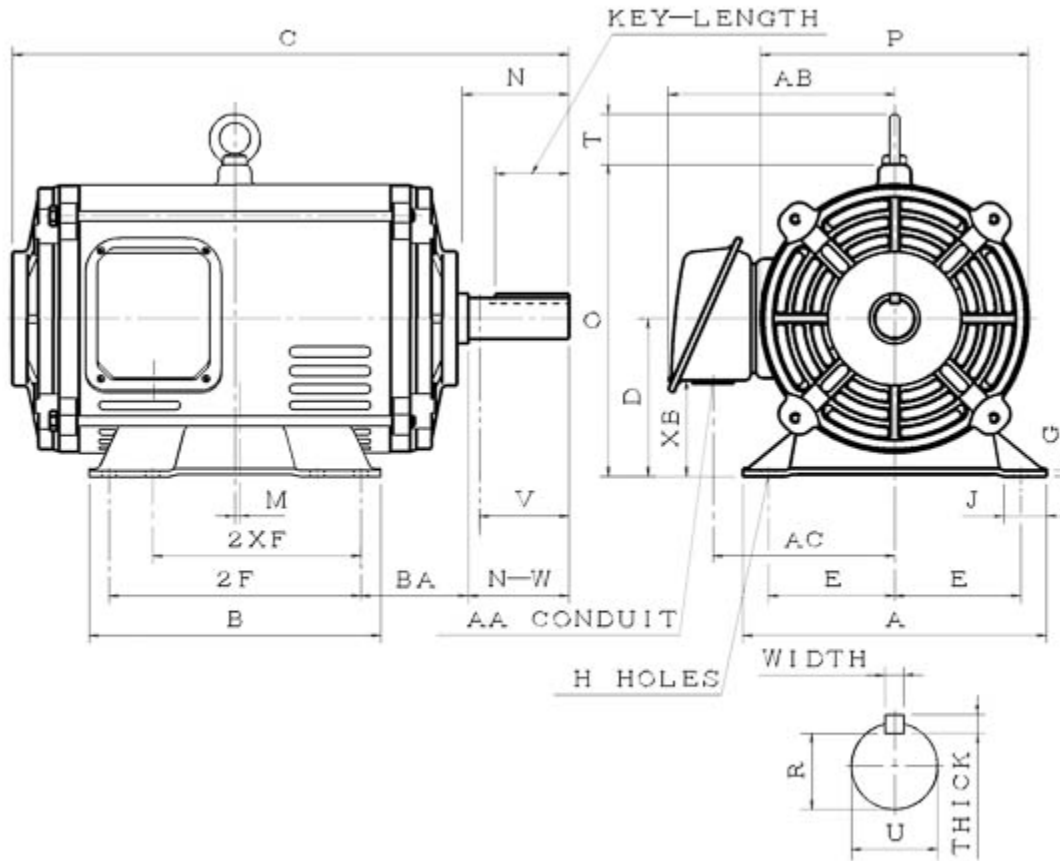

ASGH-SMP-5

Frame Size	Mounting					A	B	C	CD	D	
	E	2F	2F2	H	BA						
256T	10	10		0.53	4.25	12.05	11.57	22.48		6.25	
G	J	K	L	M	O	P	T	Key			Keyseat
0.24	1.65			0.197	12.55	10.79	2	Width	Thick	Length	R
								0.375	0.375	2.91	1.416
Terminal Housing				Aux Box		C/D Flange					
AA	AB	AC	XB	AE	AX	BB	AH	AK	BD	AJ	BF
1.38	8.99	7.2	3.81								
Shaft Extension			Bearings		Approx. Weight Lbs	SPL dBA/3ft	Ins. Class	S.F.	Drive Method	Dimensions	
N-W	U	V	DE	NDE							
4	1.625	3.9	6309ZZC3	6208ZZC3	234	60	F	1.15	Direct Coupling / Belt Drive	Inches	

### Technical Data Sheet

Motor Type: ASGH

Catalogue No: RD0204

#### Nameplate Information

HP	Pole	RPM	Frame	Voltage	Hz	Phase
20	4	1770	256T	230 / 460	60	3
Enclosure	Ins. Class	Service Factor	Time Rating	NEMA Design	Rated Amb.	Rated Altitude
ODP	F	1.15	Continuous	B	-40 to 40 °C	<3300 ft

#### Typical Performance

Efficiency (%)				Power Factor (%)		
Full Load		3/4 Load	1/2 Load	Full Load	3/4 Load	1/2 Load
Nom.	Min.					
93.0	91.7	93.0	93.0	83.0	79.0	69.0
Torque				Current (A)		
Full Load (lb-ft)	Locked Rotor (% FLT)	Pull Up (% FLT)	Break Down (% FLT)	No Load	Full Load	Locked Rotor
59.33	160	120	240	17.1 / 8.6	48.5 / 24.3	290 / 15
NEMA KVA Code	Inertia (WR <sup>2</sup> )			Safe Stall Time (s)		Noise Level Sound Press. dB(A)
	Rotor (lb-ft <sup>2</sup> )	NEMA Load (lb-ft <sup>2</sup> )	Max. Allowable (lb-ft <sup>2</sup> )	Cold	Hot	
G	2.174	99	161	17	12	60

#### VFD Duty Information

Speed Range			VFD		S.F.
Constant Torque	Variable Torque	Constant Power	Carrier	Type	
6-60Hz	3-60Hz	60-120Hz	≤ 5 kHz	VPWM or CPWM	1.0 Only

#### Additional Information

Bearings		Approx. Weight
DE	NDE	lbs
6309ZZC3	6208ZZC3	234

#### Hazardous Locations Information

N/A	
Temp Code (Sinewave / VFD)	/