

DATE
MAY 28, 2009
CATALOG # DTP0302

OUTLINE DIMENSIONS
3-PHASE INDUCTION MOTOR

MOTOR TYPE:
ASGH
FRAME NO. 284TS

Pole	HP	kW	Hz	VOLT	Syn.Speed r/min(rpm)
2	30	22.4	60	230/460	3600

Ins	Rating	Dimension in	Approx Weight	Bearings
F	CONT.	inches	273 lbs.	DE: 6311ZZC3 NDE: 6211ZZC3

Open Protected Drip-Proof Type.Squirrel-cage Rotor.

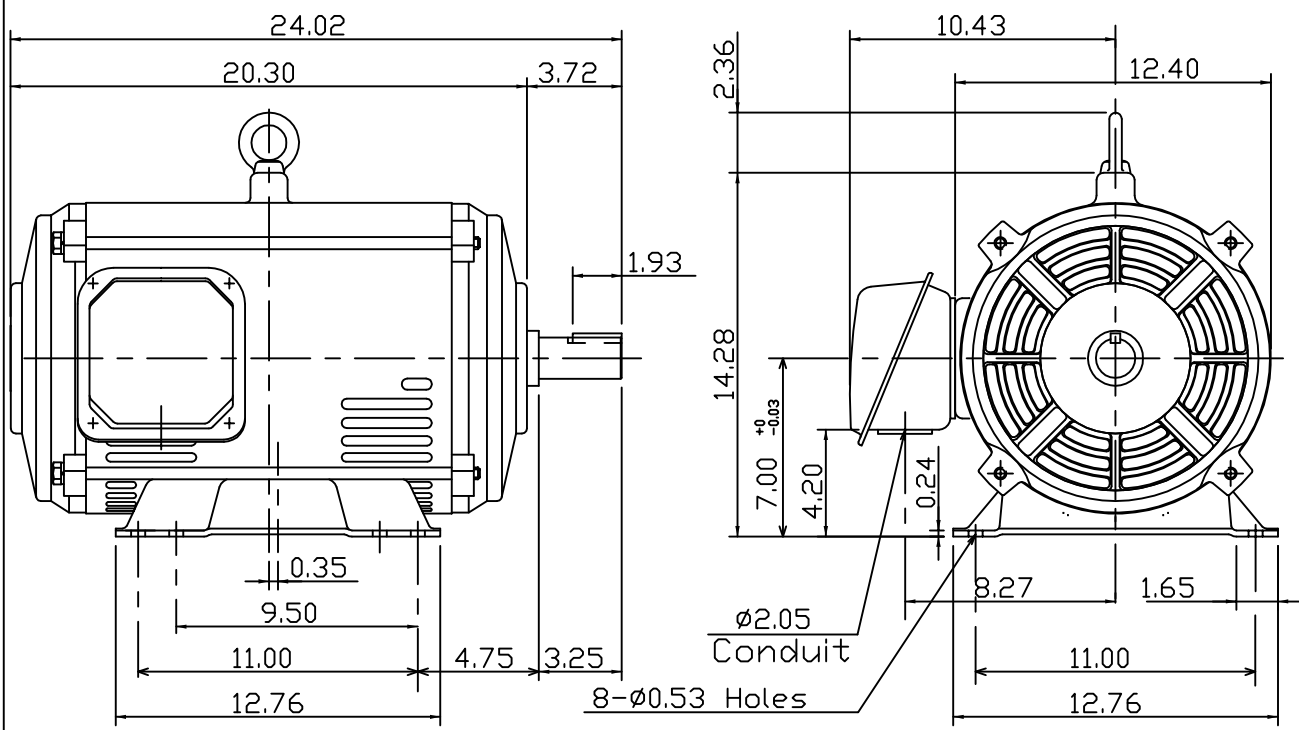

DWN.	K.L.KUD	04-23-08
CHKD.	K.L.KUD	05-05-08
APPD.	M.C.TSAI	05-05-08



DWG NO.
31057H747010