

Dimensões em polegada
Dimensions in inches

THIS IS AN UPDATED REVISION, THE
PREVIOUS ONE MUST BE DISREGARDED.

Grounding for leads 5.2–25 mm² / 10–4 AWG

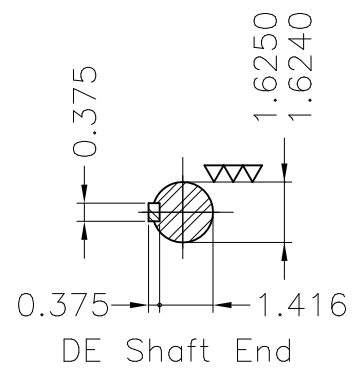
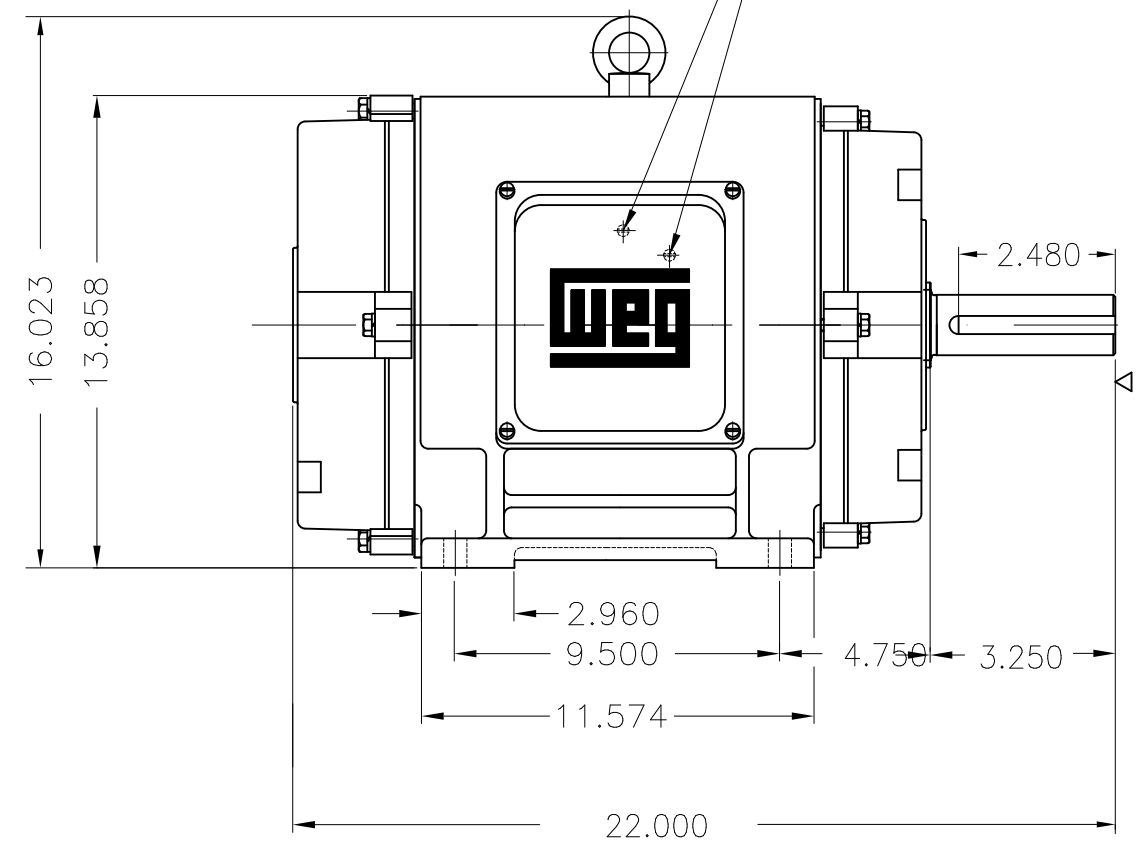
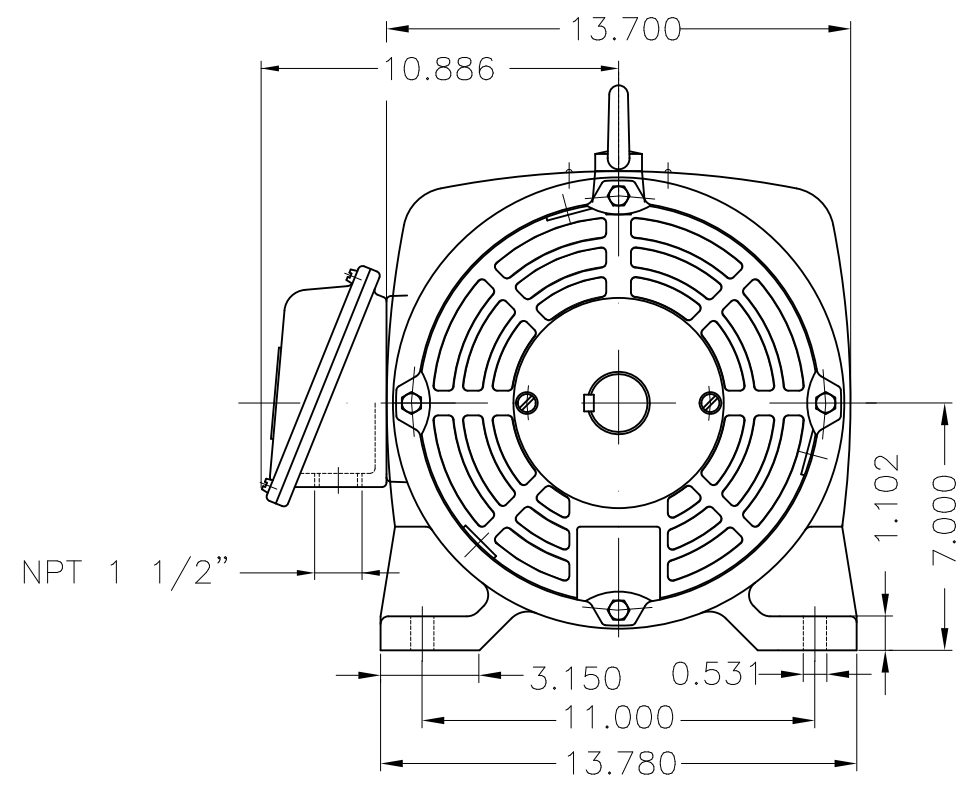

Color RAL 5009
Painting plan 203A
Mounting B3R(D)

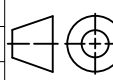
ECM	LOC	SUMMARY OF MODIFICATIONS	EXECUTED	CHECKED	RELEASED	DATE	VER
EXECUTED	USERADMIN	 THREE PHASE NEMA P. EFF MOTOR FRAME 284TS IP23 ODP WEG code: 11765398					
CHECKED							
RELEASED							
REL DT	24.07.2017		WMO Jaragua do Sul	Product Engineering	SHEET	1 / 1	

30 HP 02 Poles 60Hz

A

