

CATALOG NO. CD0756R	OUTLINE DIMENSIONS 3-PHASE INDUCTION MOTOR	MOTOR TYPE: AEEAGD
DATE JULY-20-15		FRAME NO. 405T

Pole	HP	kW	Hz	VOLT	r/min(rpm)
6	75	56	60	230/460	1200

Ins	Rating	Dimension in	Approx Weight	Bearings	
F	CONT.	inches	1243 lbs.	DE: NU317	NDE: 6313

Totally Enclosed Fan-Cooled Type, Squirrel-Cage Rotor.

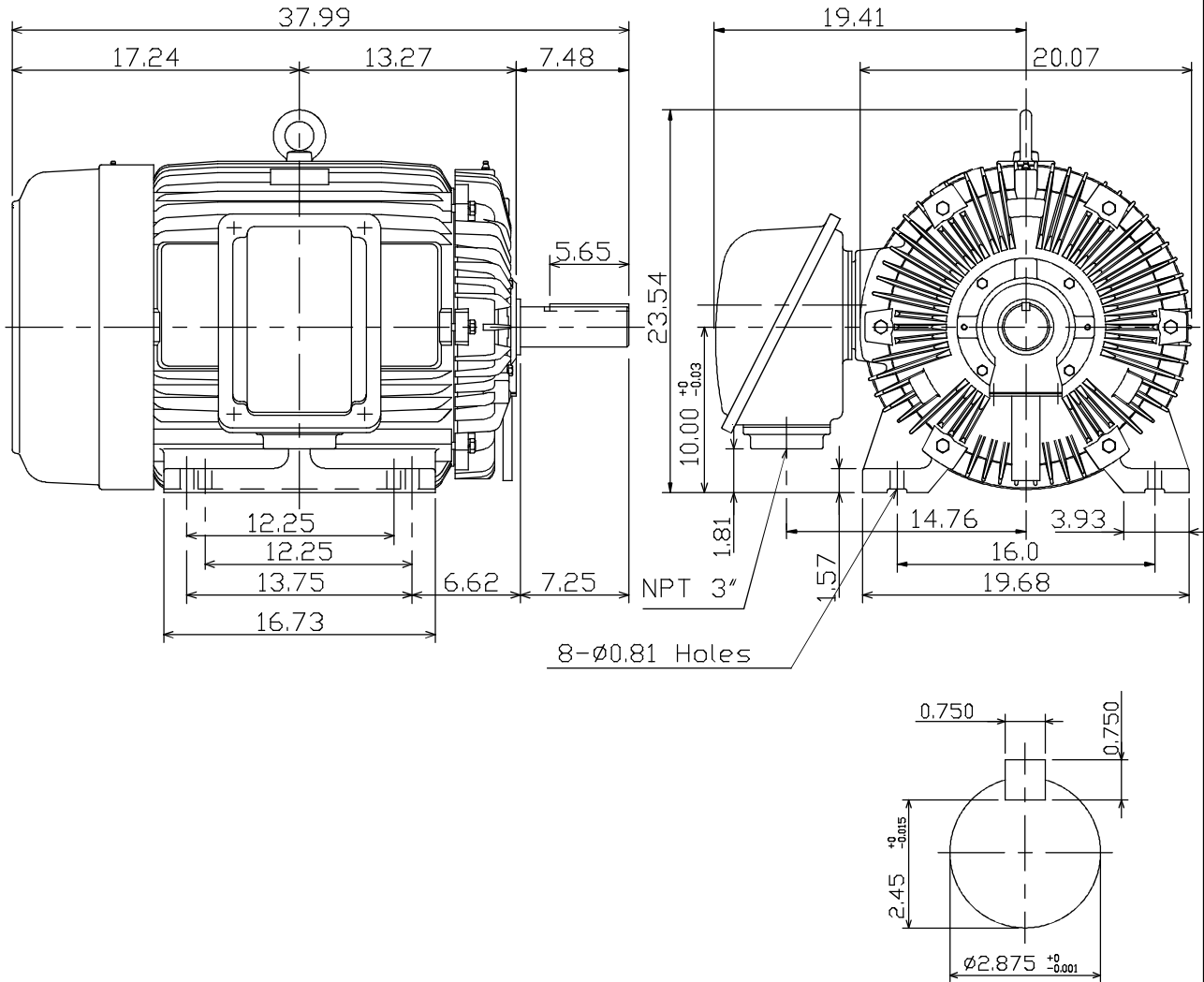

- NOTE:
1. ENCLOSURE: IP55
 2. SHAFT MATERIAL: SCM440 Q&T (AISI 4140 EQUIV)
 3. WITH THERMISTOR: PTC 140°C x 3PCS
WIRED IN MAIN TERMINAL BOX

TW-56C

	DWG. C. RAM	07 20 15
--	-------------	----------

DWG.	J.S.LIN	06.15.13	TEC Westinghouse	DWG NO.	31049J361610
CHKD.	K.L.KUD	06.15.13			
APPD.	C.H.SHYU	06.15.13			