

TYPE	OUTPUT		POLE	TIME RATING	VOLTAGE V	Hz	SYN.SPEED R.P.M
	HP.	kw.					
AEEAGD	75	56	8	CONT.	230/460	60	900

TOTALLY ENCLOSED FAN-COOLED TYPE, SQUIRREL-CAGE ROTOR

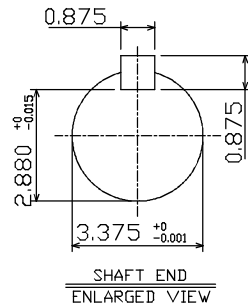
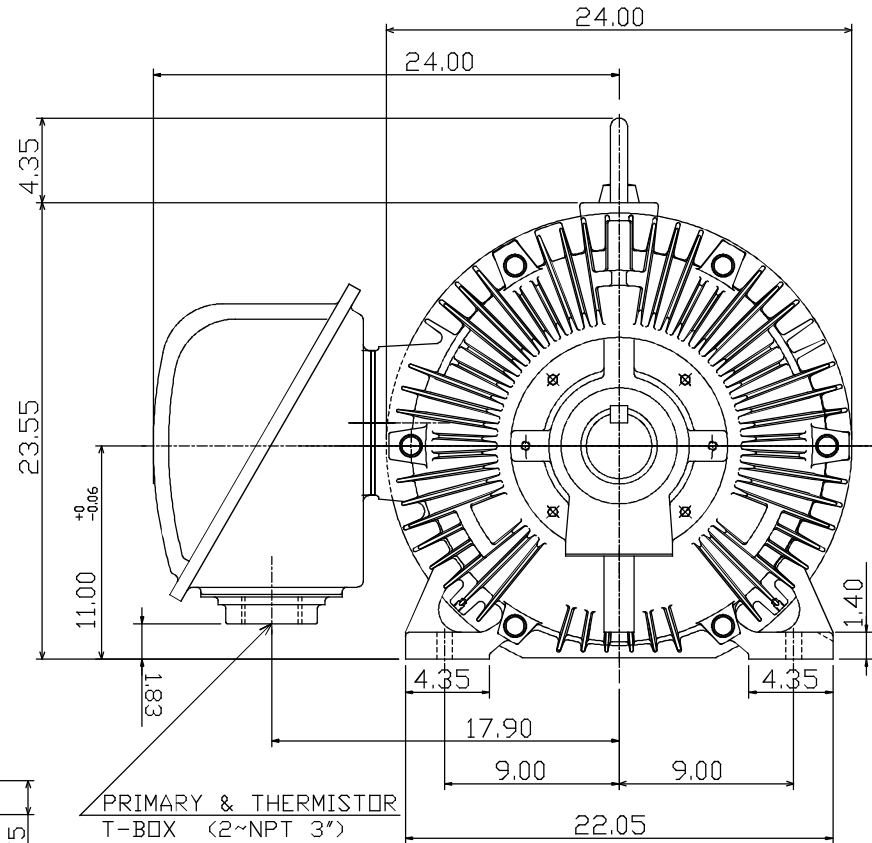
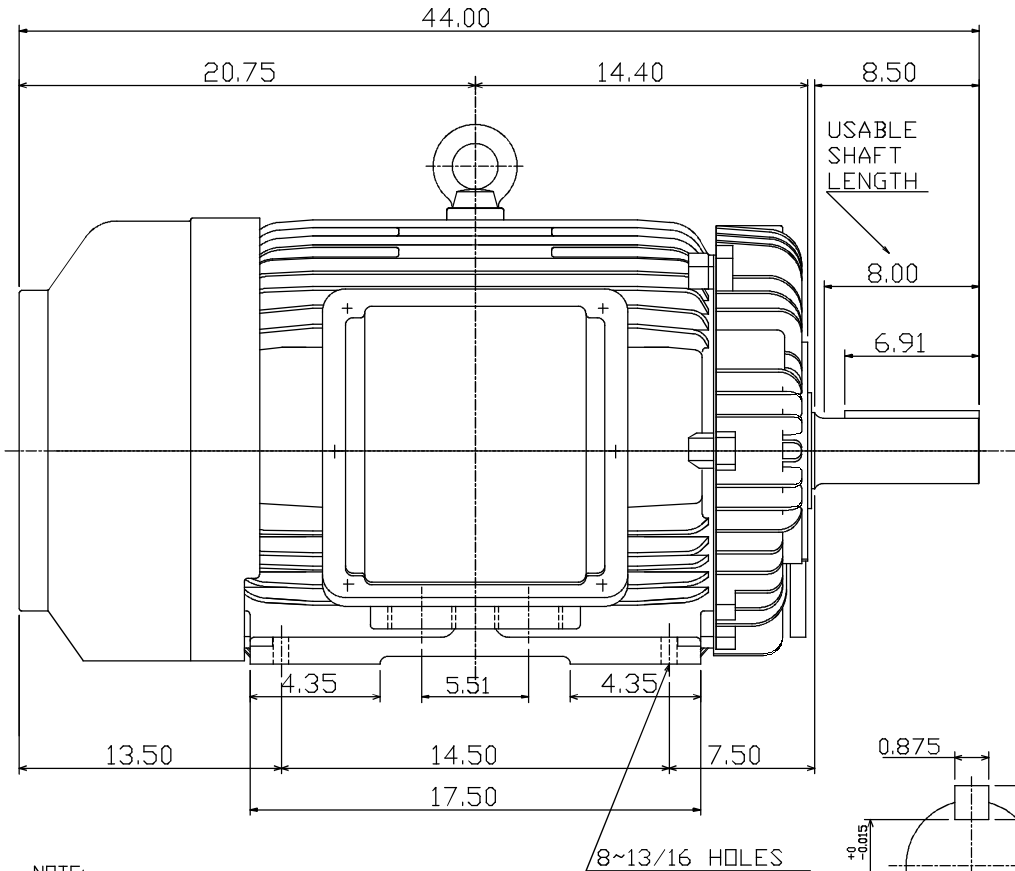

NOTE:

- DIMENSIONS IN INCHES
- FRAME NO. 444T
- F CLASS INSULATION, S.F.1.15
- FOR BELT SERVICE
- BEARING SIZE: DRIVE END: 6318C3
NON-DRIVE END: 6316C3
- ENCLOSURE: IP55
- WITH THERMISTOR: PTC 140°C 3PCS
- SHAFT MATERIAL: SCM440 Q&T (AISI 4140 EQUIV)
- CORROSION PROOF
- MOTOR APPROX. WEIGHT: 1600 LBS

TW-56BC

DWN.	C. RAM	DEC 01 2015	CATALOG NO.
DWN.	S.LEE	DEC•22•2006	CD0758
CHKD.	S.LEE	DEC•22•2006	TEC Westinghouse
APPD.	C.WANG	DEC•22•2006	

OUTLINE DIMENSIONS
3-PHASE INDUCTION MOTOR

DWG NO. REV: 00
3B040R345