

### Dimensional Drawing

Catalogue	Model	HP	Pole	kW	Rating	Voltage	Hz	RPM
SDP10065	ASHH	100	6	74.6	Continuous	575 V	60	1200

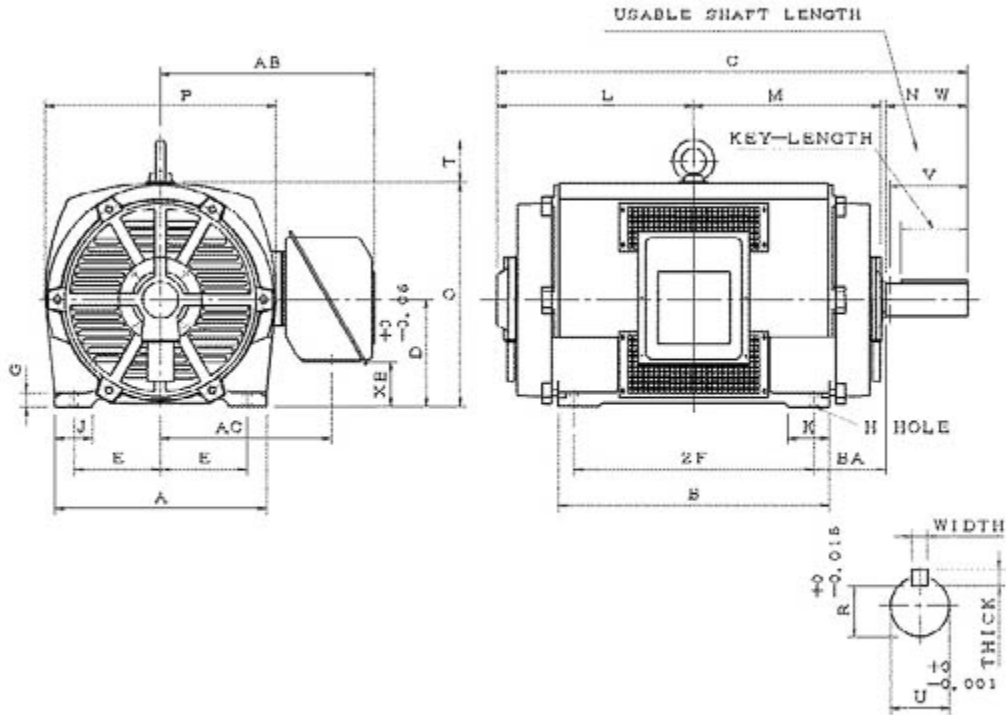

ASHH-HMP-1 1 0

Frame Size	Mounting					A	B	C	CD	D	
	E	2F	2F2	H	BA						
444T	9	14.5		0.81	7.5	22.05	17.7	38.3		11	
G	J	K	L	M	O	P	T	Key			Keyseat
1.4	3.95	3.75	15.05	14.3	22.15	22.05	3.55	Width	Thick	Length	R
								0.875	0.875	6.91	2.88
Terminal Housing				Aux Box		C/D Flange					
AA	AB	AC	XB	AE	AX	BB	AH	AK	BD	Aj	BF
	21.25	16.75	4.65								
Shaft Extension			Bearings		Approx. Weight Lbs	SPL dBA/3ft	Ins. Class	S.F.	Drive Method	Dimensions	
N-W	U	V	DE	NDE							
8.5	3.375	8	6318	6316	1170	78	F	1.15	Direct Coupling / Belt Drive	Inches	

### Technical Data Sheet

Motor Type: ASHH

Catalogue No: SDP10065

#### Nameplate Information

HP	Pole	RPM	Frame	Voltage	Hz	Phase
100	6	1181	444T	575	60	3
Enclosure	Ins. Class	Service Factor	Time Rating	NEMA Design	Rated Amb.	Rated Altitude
ODP	F	1.15	Continuous	B	-40 to 40 °C	<3300 ft

#### Typical Performance

Efficiency (%)				Power Factor (%)		
Full Load		3/4 Load	1/2 Load	Full Load	3/4 Load	1/2 Load
Nom.	Min.					
95.0	94.1	94.5	93.3	82.0	78.9	75.0
Torque				Current (A)		
Full Load (lb-ft)	Locked Rotor (% FLT)	Pull Up (% FLT)	Break Down (% FLT)	No Load	Full Load	Locked Rotor
445.00	140	120	210	38.7	96.0	580
NEMA KVA Code	Inertia (WR <sup>2</sup> )			Safe Stall Time (s)		Noise Level Sound Press. dB(A)
	Rotor (lb-ft <sup>2</sup> )	NEMA Load (lb-ft <sup>2</sup> )	Max. Allowable (lb-ft <sup>2</sup> )	Cold	Hot	
G	47.000	1181	2953	18	13	78

#### VFD Duty Information

Speed Range			VFD		S.F.
Constant Torque	Variable Torque	Constant Power	Carrier	Type	
6-60Hz	3-60Hz	60-120Hz	≤ 5 kHz	VPWM or CPWM	1.0 Only

#### Additional Information

Bearings		Approx. Weight
DE	NDE	lbs
6318	6316	1170

#### Hazardous Locations Information

N/A	
0	
0	
Temp Code (Sinewave / VFD)	0 / 0