

Dimensional Drawing

Catalogue	Model	HP	Pole	kW	Rating	Voltage	Hz	RPM
APH2508-841	AEHH8B	250	8	187	Continuous	460 V	60	900

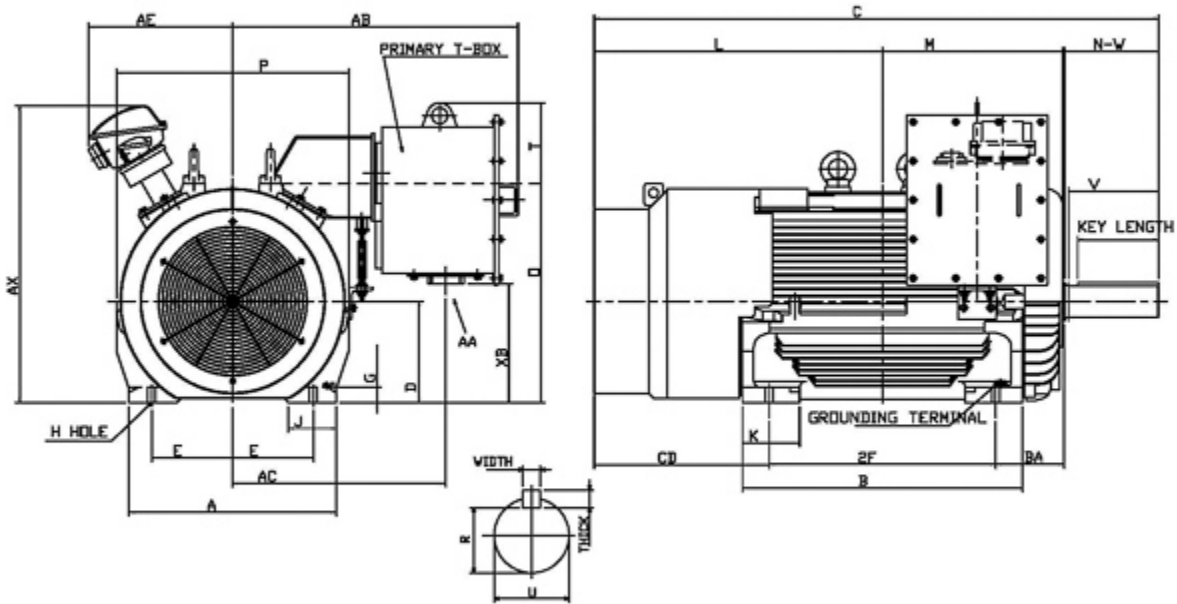

Frame Size	Mounting					A	B	C	CD	D	
	E	2F	2F2	H	BA						
5009B	10	28		0.94	8.5	25.6	34.65	69.75		12.5	
G	J	K	L	M	O	P	T	Key			Keyseat
								Width	Thick	Length	R
1.85	5.9	7.1	35.63	22.1	27.07	28.75	14.7	1	1	10	3.309
Terminal Housing			Aux Box			C/D Flange					
AA	AB	AC	XB	AE	AX	BB	AH	AK	BD	AJ	BF
	36.95	24.8	14.67	17.83	36.67						
Shaft Extension			Bearings		Approx. Weight Lbs	SPL dBA/3ft	Ins. Class	S.F.	Drive Method	Dimensions	
N-W	U	V	DE	NDE							
11.62	3.875	11.12	6324C3	6320C3	3784	80	F	1.15	Direct Coupling	Inches	

Technical Data Sheet

Motor Type: AEHH8B

Catalogue No: APH2508-841

Nameplate Information

HP	Pole	RPM	Frame	Voltage	Hz	Phase
250	8	890	5009B	460	60	3
Enclosure	Ins. Class	Service Factor	Time Rating	NEMA Design	Rated Amb.	Rated Altitude
TEFC	F	1.15	Continuous	B	-40 to 40 °C	<3300 ft

Typical Performance

Efficiency (%)				Power Factor (%)		
Full Load		3/4 Load	1/2 Load	Full Load	3/4 Load	1/2 Load
Nom.	Min.					
94.5	93.6	94.4	94.0	81.0	78.0	69.0
Torque				Current (A)		
Full Load (lb-ft)	Locked Rotor (% FLT)	Pull Up (% FLT)	Break Down (% FLT)	No Load	Full Load	Locked Rotor
1474.72	110	100	200	102.0	305.8	1825
NEMA KVA Code	Inertia (WR ²)			Safe Stall Time (s)		Noise Level Sound Press. dB(A)
	Rotor (lb-ft ²)	NEMA Load (lb-ft ²)	Max. Allowable (lb-ft ²)	Cold	Hot	
0	235.000	5535	11070	23	18	80

VFD Duty Information

Speed Range			VFD		S.F.
Constant Torque	Variable Torque	Constant Power	Carrier	Type	
20-60Hz	3-60Hz	60-90Hz	≤ 5 kHz	VPWM or CPWM	0

Additional Information

Bearings		Approx. Weight
DE	NDE	lbs
6324C3	6320C3	3784

Hazardous Locations Information

CSA Certified	
Class I, Div 2, Groups B, C & D Class I, Zone 2, Groups IIB+H2, IIB & IIA	
Temp Code (Sinewave / VFD)	T3 / T3