

Dimensional Drawing

Catalogue	Model	HP	Pole	kW	Rating	Voltage	Hz	RPM
PDH60045	AEHE	600	4	448	Continuous	575 V	60	1800

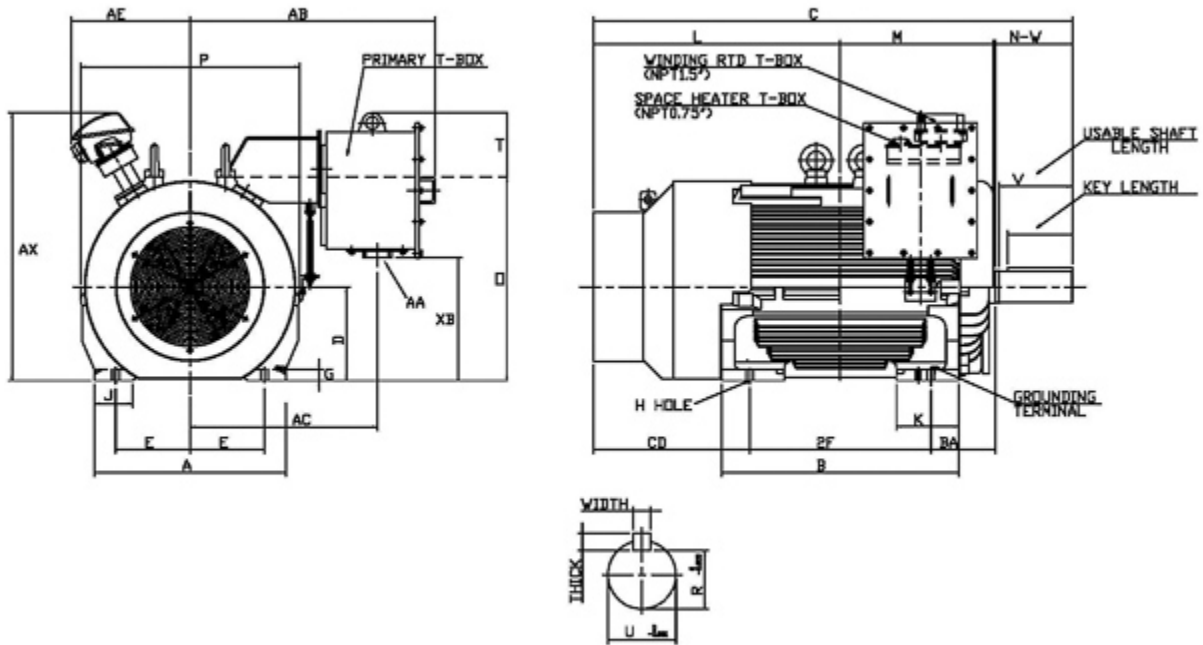

Frame Size	Mounting					A	B	C	CD	D	
	E	2F	2F2	H	BA						
5808B	11.5	28		1.13	10	29.55	36.6	74.08	24.19	14.5	
G	J	K	L	M	O	P	T	Key			Keyseat
1.7	5.9	9.65	38.2	23.4	31.45	33.85	9.45	Width	Thick	Length	R
								1.25	1.25	10	4.169
Terminal Housing				Aux Box		C/D Flange					
AA	AB	AC	XB	AE	AX	BB	AH	AK	BD	AJ	BF
2x 3 NPT	30.5	24.4	21.1	18.34	41.39						
Shaft Extension			Bearings		Approx. Weight Lbs	SPL dBA/3ft	Ins. Class	S.F.	Drive Method	Dimensions	
N-W	U	V	DE	NDE							
11.88	4.875	11.38	6326	6322	5874	83	F	1.15	Direct Coupling	Inches	

Technical Data Sheet

Motor Type: AEHE

Catalogue No: PDH60045

Nameplate Information

HP	Pole	RPM	Frame	Voltage	Hz	Phase
600	4	1785	5808B	575	60	3
Enclosure	Ins. Class	Service Factor	Time Rating	NEMA Design	Rated Amb.	Rated Altitude
TEFC	F	1.15	Continuous	B	-40 to 40 °C	<3300 ft

Typical Performance

Efficiency (%)				Power Factor (%)		
Full Load		3/4 Load	1/2 Load	Full Load	3/4 Load	1/2 Load
Nom.	Min.					
95.5	94.6	95.2	94.0	90.0	89.0	84.0
Torque				Current (A)		
Full Load (lb-ft)	Locked Rotor (% FLT)	Pull Up (% FLT)	Break Down (% FLT)	No Load	Full Load	Locked Rotor
1764.71	95	95	200	88.8	522.9	3784
NEMA KVA Code	Inertia (WR ²)			Safe Stall Time (s)		Noise Level Sound Press. dB(A)
	Rotor (lb-ft ²)	NEMA Load (lb-ft ²)	Max. Allowable (lb-ft ²)	Cold	Hot	
0	422.000	2202.0	3303.0	26	20	83

VFD Duty Information

Speed Range			VFD		S.F.
Constant Torque	Variable Torque	Constant Power	Carrier	Type	
20-60Hz	3-60Hz	60-60Hz	≤ 5 kHz	VPWM or CPWM	

Additional Information

Bearings		Approx. Weight
DE	NDE	lbs
6326	6322	5874

Hazardous Locations Information

CSA Certified	
Class I, Div 2, Groups B, C & D Class I, Zone 2, Groups IIB+H2, IIB & IIA	
Temp Code (Sinewave / VFD)	T3 (1.0 SF) / T2B