

DATE
JUNE 27, 2011
CAT. #: NP0606C

OUTLINE DIMENSIONS
3-PHASE INDUCTION MOTOR

MOTOR TYPE:
AEHH8P-CF
FRAME NO. 404TC

Pole	HP	kW	Hz	VOLT	Syn.Speed r/min(rpm)
6	60	45	60	230/460	1200

Ins	Rating	Dimension in	Approx Weight	Bearings	
F	CONT.	inch	1220 lbs.	DE: 6317	NDE: 6313

Totally Enclosed Fan Cooled Type.Squirrel-cage Rotor.

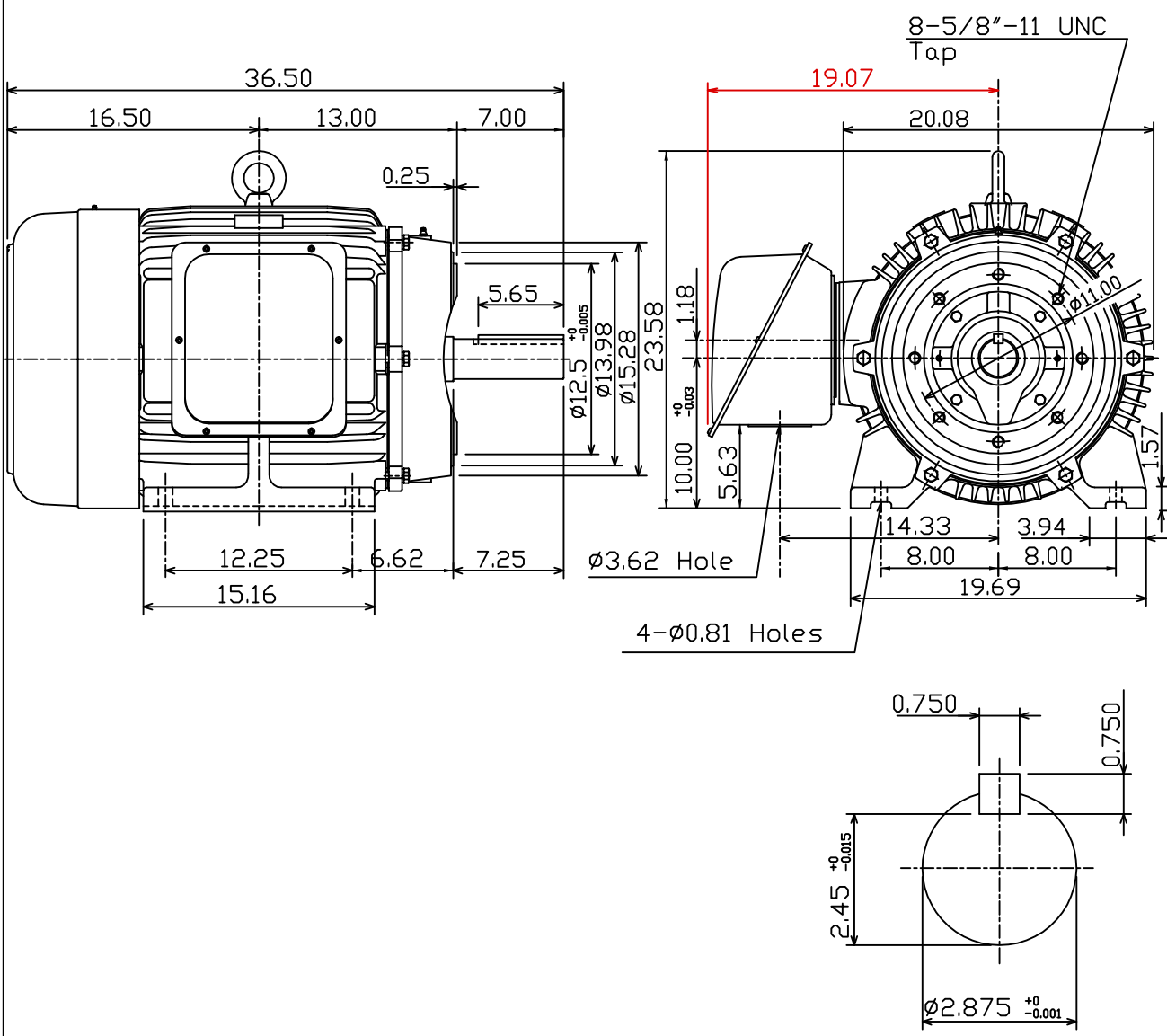

DWN.	K.L.KUD	04 -21 11
CHKD.	K.L.KUD	04 -21 11
APPD.	M.C.TSAI	04 -21 11



DWG NO.
31049M240330