

ROTATION
UNITS
BI-DIRECTIONAL
SEE NOTE 6

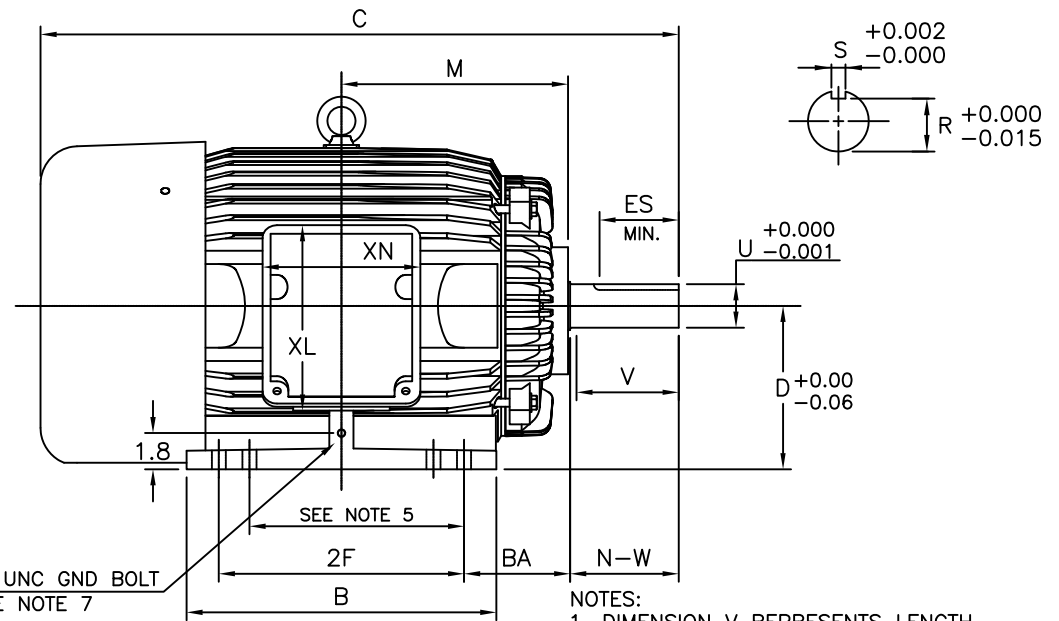
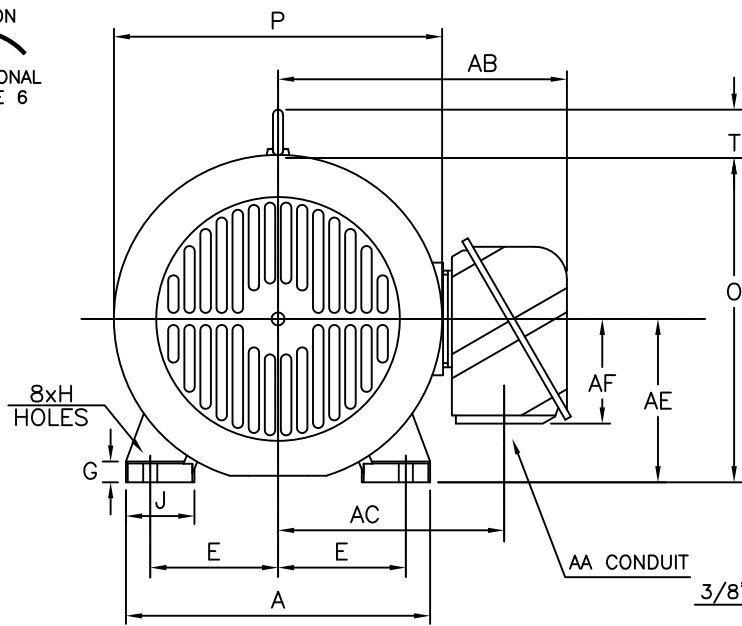

3/8"-16 UNC GND BOLT
SEE NOTE 7

NOTES:

1. DIMENSION V REPRESENTS LENGTH OF STRAIGHT PART OF SHAFT
2. MAIN CONDUIT BOX MAY BE ROTATED IN 90° INCREMENTS
3. KEY DIMENSIONS EQUAL S x S x 3.88 FOR T AND S x S x 2.00 FOR TS (MOTOR SUPPLIED WITH KEY)
4. MOTOR WEIGHT SHOWN IS MAXIMUM HORSEPOWER IN FRAME
5. THIS DIMENSION EQUALS 2F FOR 324T/TS MOUNTING
6. STANDARD PRODUCT USE BI-DIRECTIONAL FAN. OPPOSITE ROTATION AVAILABLE ONLY BY CONNECTION CHANGE
7. FRAME GROUND BOLT STANDARD ON 841 PRODUCT

UNITS: INCHES

FRAME SIZE	MOTOR DIMENSIONS											CONDUIT BOX						
	A	B	C	D	G	J	K	M	O	P	T	AA[NPT]	AB	AC	AE	AF	XL	XN
324TS/326TS	14.9	15.2	29.7	8.00	0.9	3.2	0	11.1	15.9	16.1	2.4	2.00	14.3	11.1	8.00	5.1	9.1	7.7
324T/326T	14.9	15.2	31.2	8.00	0.9	3.2	0	11.1	15.9	16.1	2.4	2.00	14.3	11.1	8.00	5.1	9.1	7.7

FRAME SIZE	MOUNTING				SHAFT EXTENSION			KEY SEAT			BEARINGS		MAXIMUM WEIGHT
	E	2F	H	BA	N-W	V	U	R	S	ES	LS	OS	
324TS/326TS	6.25	10.50/12.00	0.69	5.25	3.75	3.50	1.875	1.591	0.500	2.00	6312C3	6312C3	650 lbs.
324T/326T	6.25	10.50/12.00	0.69	5.25	5.25	5.00	2.125	1.845	0.500	3.88	6312C3	6312C3	650 lbs.

CUSTOMER: _____ MOTOR MODEL NO.: _____
 P.O. NO.: _____ HP: _____ VOLTAGE: _____ RPM(SYN.): _____ Hz: _____
 FRAME SIZE: _____ PRODUCT TYPE: EQP III 840 & 841
 COMMENTS: _____

TAG NO's.: _____

PER: _____ DATE: _____

- STANDARD (NO AUX. BOXES)
- RTD AUX. BOX
- SPACE HEATER AUX. BOX
- BEARING RTD's

TOSHIBA RESERVES THE RIGHT TO MAKE CHANGES OF TECHNICAL IMPROVEMENT AND THE DATA MAY CHANGE WITHOUT NOTICE PRELIMINARY

DO NOT USE FOR CONSTRUCTION, INSTALLATION, OR APPLICATION PURPOSES UNLESS THE DRAWING IS MARKED AS CERTIFIED CERTIFIED

TOSHIBA

TOSHIBA INTERNATIONAL CORPORATION

TOTALLY-ENCLOSED FAN-COOLED
HORIZONTAL FOOT-MOUNTED
3 PHASE INDUCTION MOTOR
F1 ASSEMBLY

XT SERIES

VISIT OUR WEBSITE AT:
www.toshiba.com/ind