

Dimensional Drawing

Catalogue	Model	HP	Pole	kW	Rating	Voltage	Hz	RPM
APH0014-841	AEHH8B	1	4	0.75	Continuous	460 V	60	1800

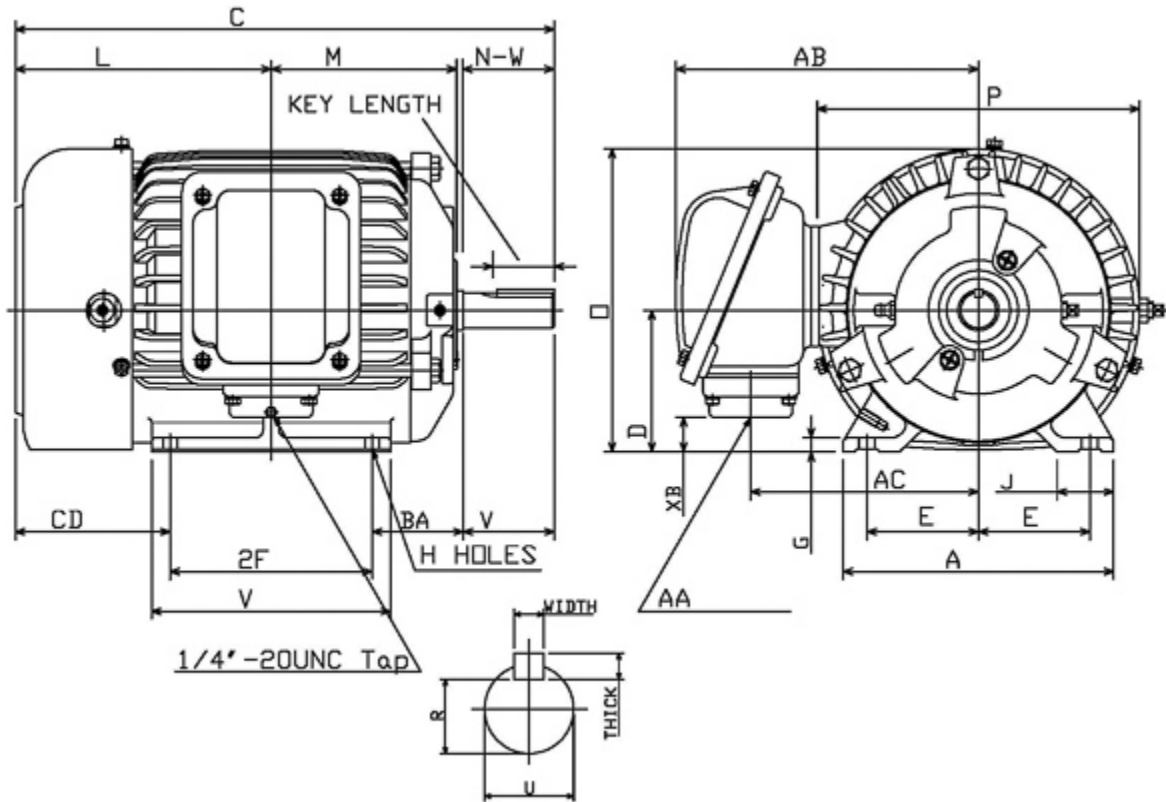

Frame Size	Mounting					A	B	C	CD	D	
	E	2F	2F2	H	BA						
143T	2.75	4		0.34	2.25	6.7	5.1	12.56		3.5	
G	J	K	L	M	O	P	T	Key			Keyseat
0.35	1.4		6.06	4.03	7.48	7.95		Width	Thick	Length	R
								0.188	0.188	1.41	0.771
Terminal Housing			Aux Box			C/D Flange					
AA	AB	AC	XB	AE	AX	BB	AH	AK	BD	AJ	BF
NPT3/4"	7.56	5.63	0.86								
Shaft Extension			Bearings		Approx. Weight Lbs	SPL dBA/3ft	Ins. Class	S.F.	Drive Method	Dimensions	
N-W	U	V	DE	NDE							
2.25	0.875	2.2	6205ZC3	6205ZC3	55	49	F	1.15	Direct Coupling / Belt Drive	Inches	

Technical Data Sheet

Motor Type: AEHH8B

Catalogue No: APH0014-841

Nameplate Information

HP	Pole	RPM	Frame	Voltage	Hz	Phase
1	4	1745	143T	460	60	3
Enclosure	Ins. Class	Service Factor	Time Rating	NEMA Design	Rated Amb.	Rated Altitude
TEFC	F	1.15	Continuous	B	-40 to 40 °C	<3300 ft

Typical Performance

Efficiency (%)				Power Factor (%)		
Full Load		3/4 Load	1/2 Load	Full Load	3/4 Load	1/2 Load
Nom.	Min.					
85.5	82.5	84.0	81.5	73.0	64.5	51.5
Torque				Current (A)		
Full Load (lb-ft)	Locked Rotor (% FLT)	Pull Up (% FLT)	Break Down (% FLT)	No Load	Full Load	Locked Rotor
3.01	310	280	410	0.8	1.5	15
NEMA KVA Code	Inertia (WR ²)			Safe Stall Time (s)		Noise Level Sound Press. dB(A)
	Rotor (lb-ft ²)	NEMA Load (lb-ft ²)	Max. Allowable (lb-ft ²)	Cold	Hot	
N	0.086	5.8	46	71	50	49

VFD Duty Information

Speed Range			VFD		S.F.
Constant Torque	Variable Torque	Constant Power	Carrier	Type	
6-60Hz	3-60Hz	60-120Hz	≤ 5 kHz	VPWM or CPWM	1.0 Only

Additional Information

Bearings		Approx. Weight
DE	NDE	lbs
6205ZC3	6205ZC3	55

Hazardous Locations Information

CSA Certified	
Class I, Div 2, Groups B, C & D	
Class I, Zone 2, Groups IIB+H2, IIB & IIA	
Temp Code (Sinewave / VFD)	T3C / T3C