

Dimensões em polegada
Dimensions in inches

THIS IS AN UPDATED REVISION, THE
PREVIOUS ONE MUST BE DISREGARDED.

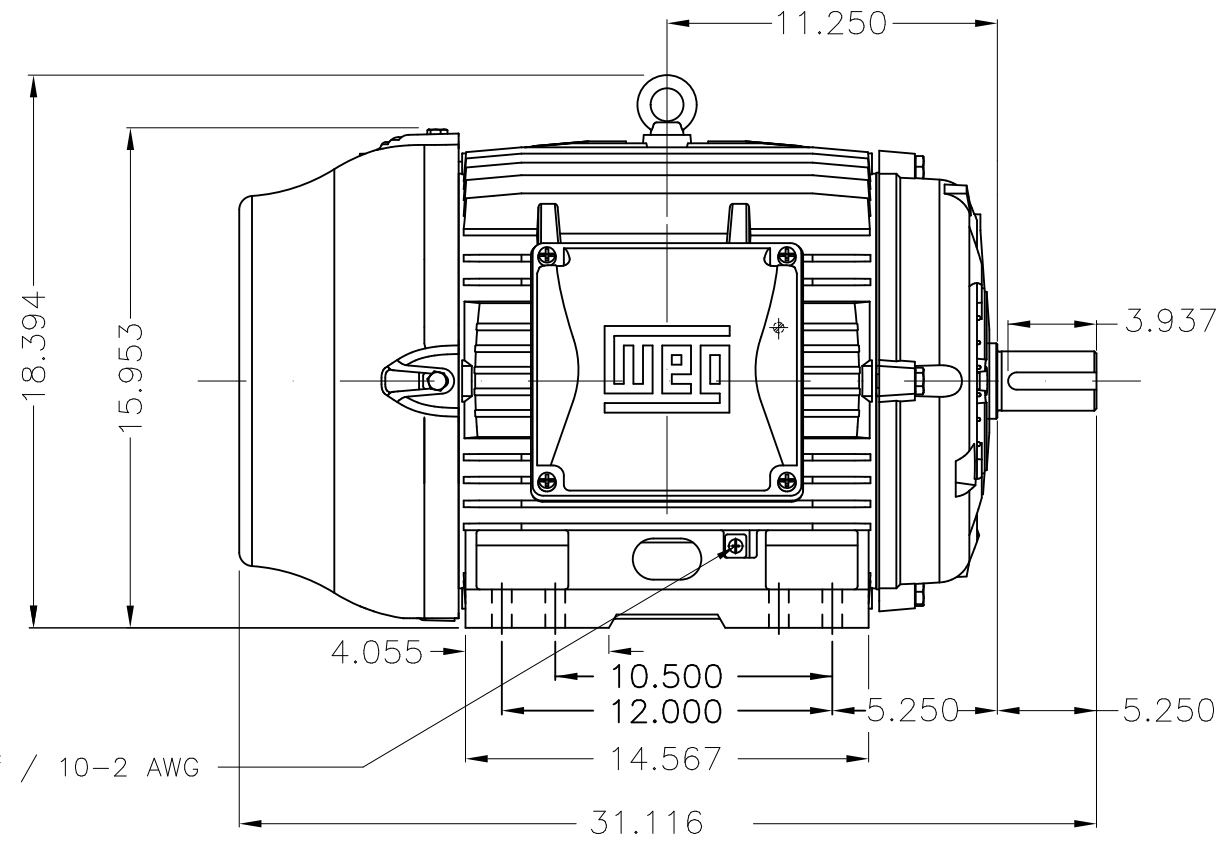

Grounding for leads 5.2–35 mm² / 10–2 AWG

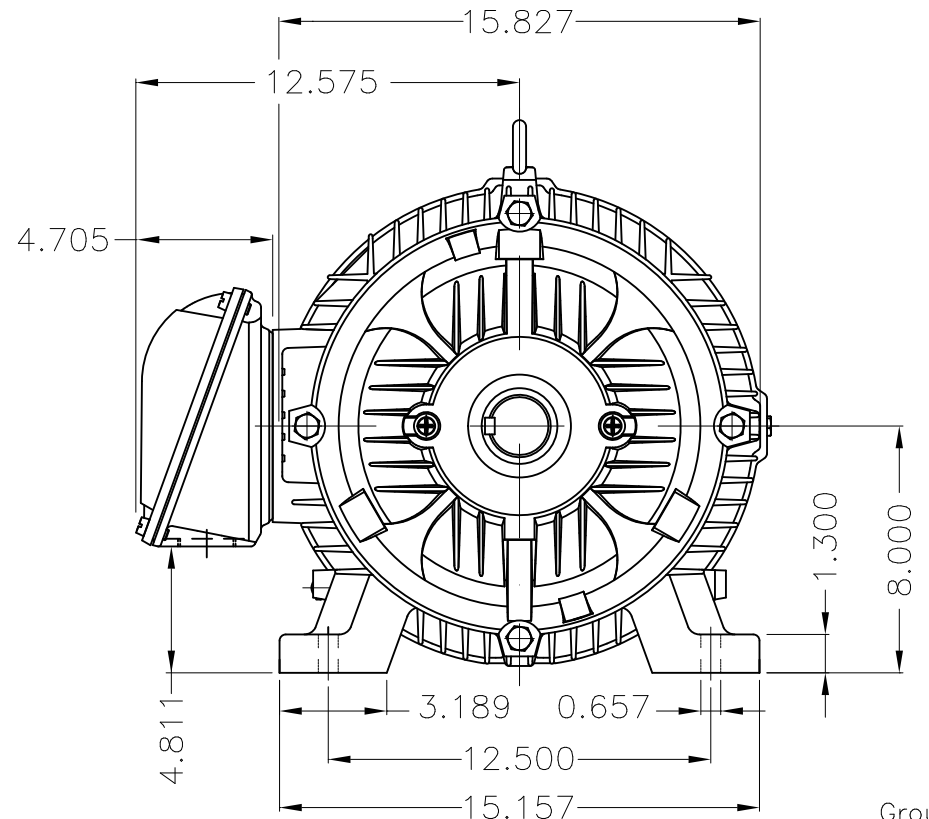

Grounding for leads 5.2–35 mm² / 10–2 AWG

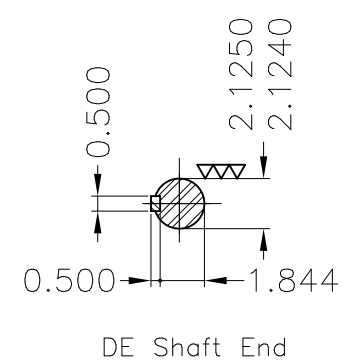

Color RAL 5009
Painting plan 202E
Mounting B3R(D)

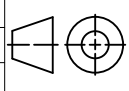
ECM	LOC	SUMMARY OF MODIFICATIONS			EXECUTED	CHECKED	RELEASED	DATE	VER
EXECUTED	USERADMIN	 THREE PH. W22 NEMA P.EFF MOTOR IEEEE841 FRAME 324/6T IP55 TEFC WEG code: 11431847							
CHECKED									
RELEASED									
REL DT	24.07.2017	WMO	Jaragua do Sul	Product Engineering	SHEET	1 / 1			

30 HP 06 Poles 60Hz

A

