

Dimensional Drawing

Catalogue	Model	HP	Pole	kW	Rating	Voltage	Hz	RPM
PDH01525C	AEHH8N	15	2	11	Continuous	575 V	60	3600

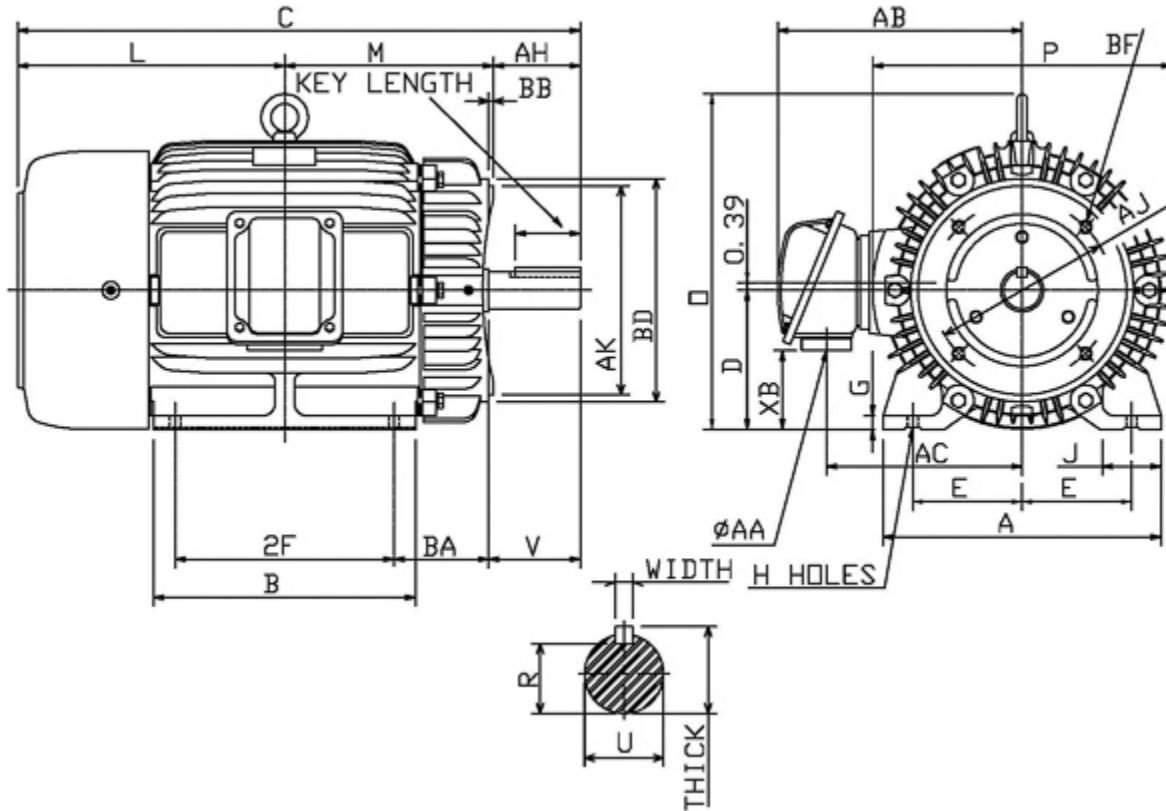

Frame Size	Mounting					A	B	C	CD	D	
	E	2F	2F2	H	BA						
254TC	5	8.25		0.53	4.25	11.8	9.85	23.7		6.25	
G	J	K	L	M	O	P	T	Key			Keyseat R
								Width	Thick	Length	
0.65	1.95		11.33	8.06	12.83	13.15	1.97	0.375	0.375	2.91	1.416
Terminal Housing			Aux Box			C/D Flange					
AA	AB	AC	XB	AE	AX	BB	AH	AK	BD	AJ	BF
1.25 NPT	11.3	8.86	3.22			0.25	3.75	8.5	9.92	7.25	1/2-13UNC
Shaft Extension			Bearings		Approx. Weight Lbs	SPL dBA/3ft	Ins. Class	S.F.	Drive Method	Dimensions	
N-W	U	V	DE	NDE							
4	1.625	3.9	6309ZZ	6307ZZ	301	73	F	1.15	Direct Coupling / Belt Drive	Inches	

Technical Data Sheet

Motor Type: AEHH8N

Catalogue No: PDH01525C

Nameplate Information

HP	Pole	RPM	Frame	Voltage	Hz	Phase
15	2	3525	254TC	575	60	3
Enclosure	Ins. Class	Service Factor	Time Rating	NEMA Design	Rated Amb.	Rated Altitude
TEFC	F	1.15	Continuous	B	-40 to 40 °C	<3300 ft

Typical Performance

Efficiency (%)				Power Factor (%)		
Full Load		3/4 Load	1/2 Load	Full Load	3/4 Load	1/2 Load
Nom.	Min.					
92.4	91.0	92.4	91.7	91.5	90.5	86.0
Torque				Current (A)		
Full Load (lb-ft)	Locked Rotor (% FLT)	Pull Up (% FLT)	Break Down (% FLT)	No Load	Full Load	Locked Rotor
22.34	210	180	270	3.0	13.3	93
NEMA KVA Code	Inertia (WR ²)			Safe Stall Time (s)		Noise Level Sound Press. dB(A)
	Rotor (lb-ft ²)	NEMA Load (lb-ft ²)	Max. Allowable (lb-ft ²)	Cold	Hot	
G	1.088	16.0	41.0	17	12	73

VFD Duty Information

Speed Range			VFD		S.F.
Constant Torque	Variable Torque	Constant Power	Carrier	Type	
6-60Hz	3-60Hz	60-90Hz	≤ 5 kHz	VPWM or CPWM	

Additional Information

Bearings		Approx. Weight
DE	NDE	lbs
6309ZZ	6307ZZ	301

Hazardous Locations Information

CSA Certified	
Class I, Div 2, Groups B, C & D	
Class I, Zone 2, Groups IIB+H2, IIB & IIA	
Temp Code (Sinewave / VFD)	T3C / T3B