

Dimensões em mm
Dimensions in mm

THIS IS AN UPDATED REVISION, THE
PREVIOUS ONE MUST BE DISREGARDED.

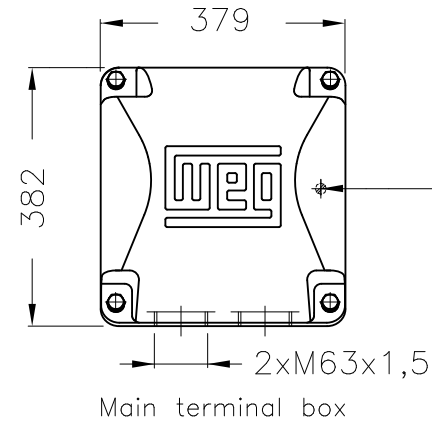

Grounding for leads 35–70 mm² / 1–2/0 AWG

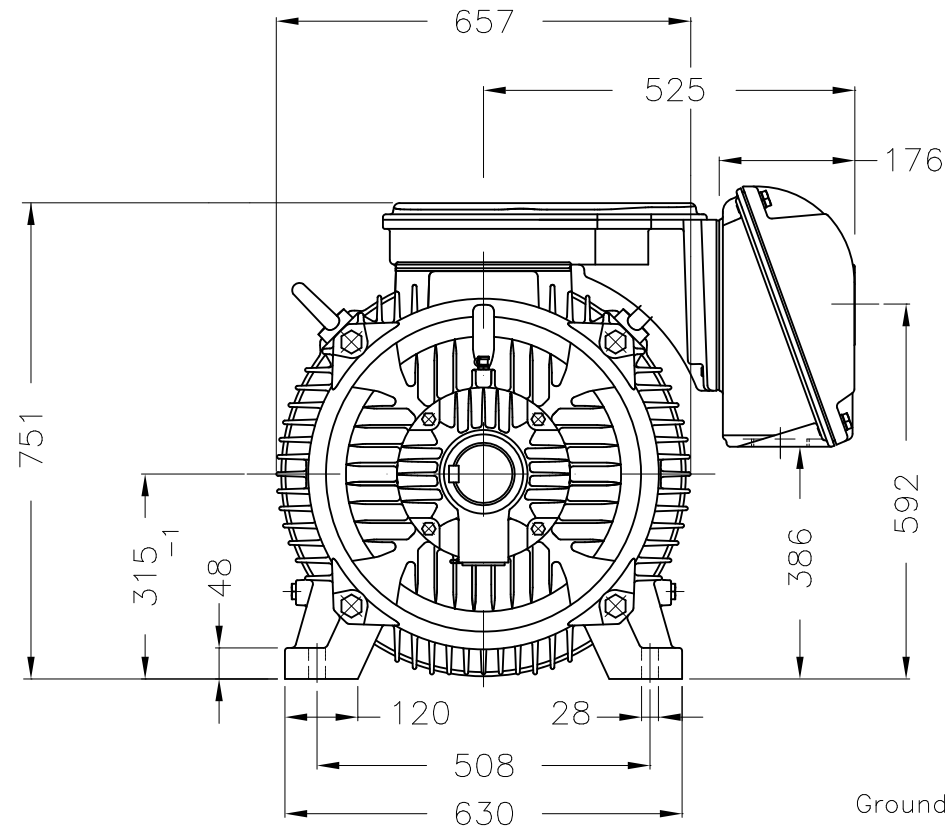
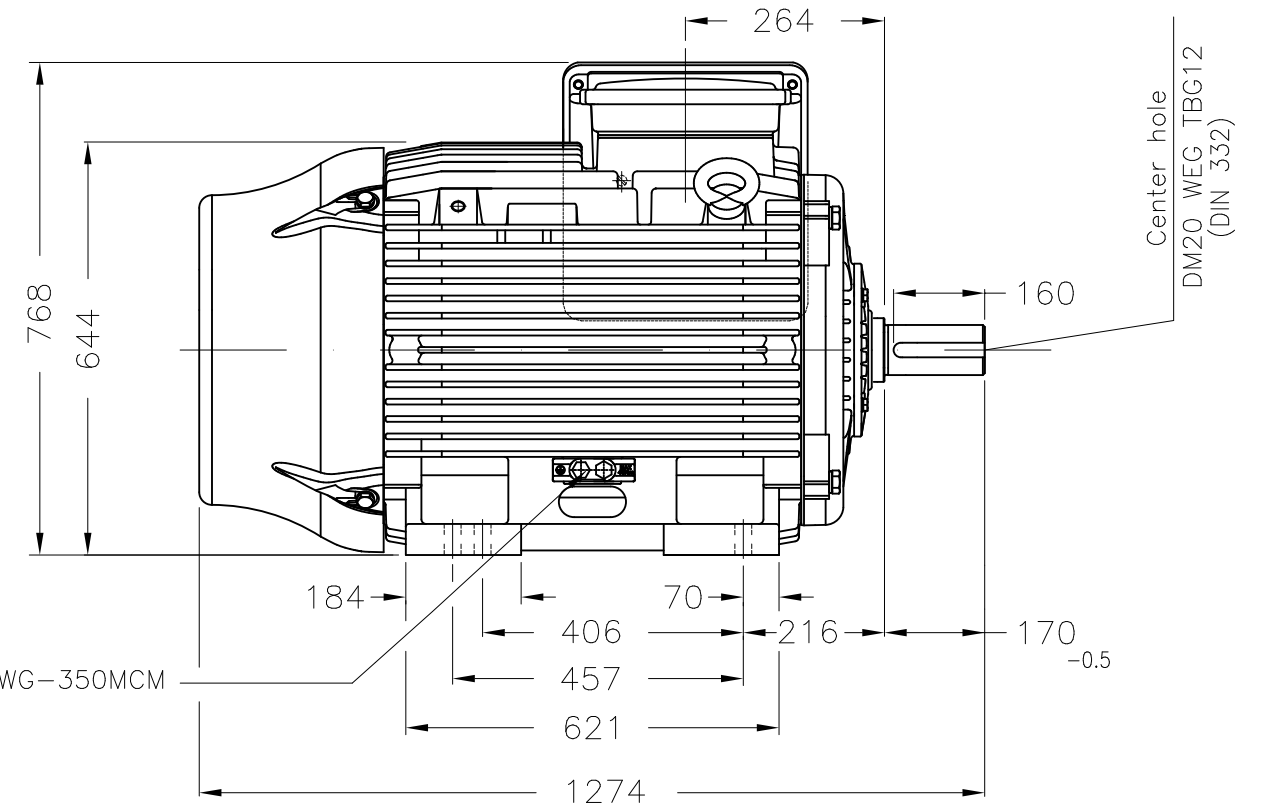

Grounding for leads 25–185 mm² / 3AWG–350MCM

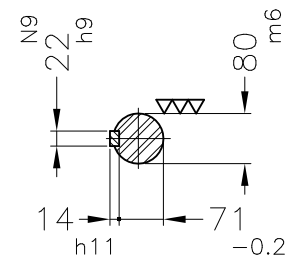

DE Shaft End

NDE endshield with electrically insulated bearing hub
Color RAL 5009
Painting plan 203A
Mounting B3L(E)

ECM	LOC	SUMMARY OF MODIFICATIONS			EXECUTED	CHECKED	RELEASED	DATE	VER
EXECUTED	USERADMIN		THREE PHASE W22 TRU-METRIC PREMIUM EFF						
CHECKED			FRAME 315S/M IP55 TEFC						
RELEASED			WEG code: 11767240						
REL DT	24.07.2017	WMO	Jaragua do Sul	Product Engineering	SHEET	1 / 1			

175 HP 06 Poles 60Hz

