

| TYPE | OUTPUT | | POLE | TIME RATING | VOLTAGE V | Hz | SYN. SPEED R. P. M |
|--------|--------|-----|------|-------------|-----------|----|--------------------|
| | HP. | KW. | | | | | |
| AEEAGD | 400 | 298 | 8 | CONT. | 460 | 60 | 900 |

TOTALLY ENCLOSED FAN-COOLED TYPE. SQUIRREL-CAGE ROTOR

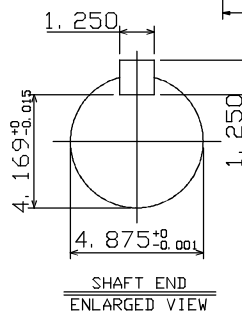
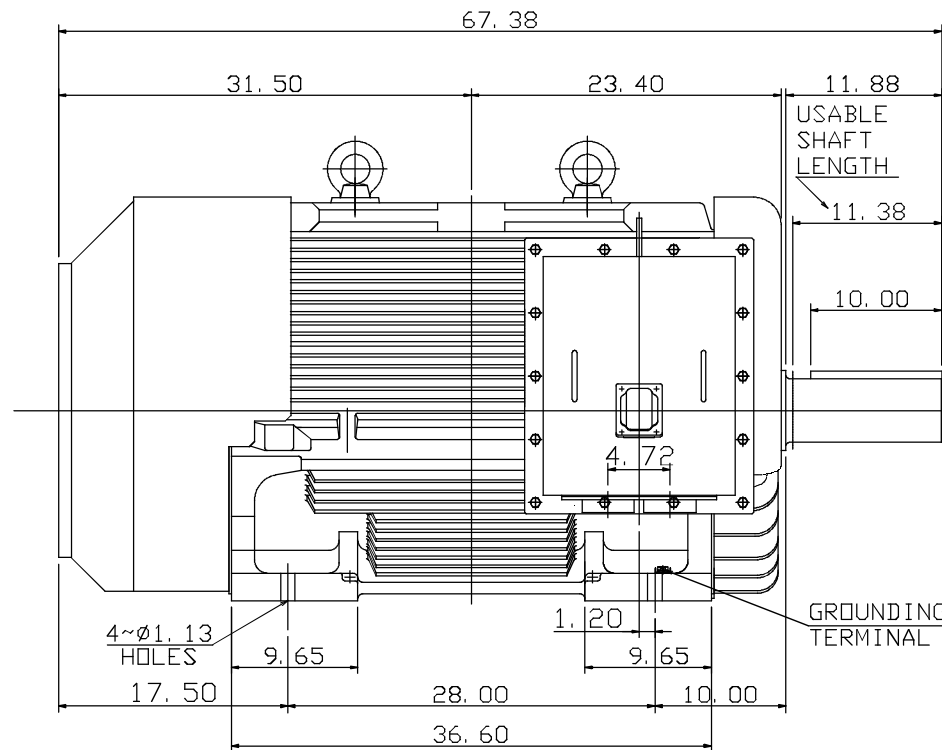
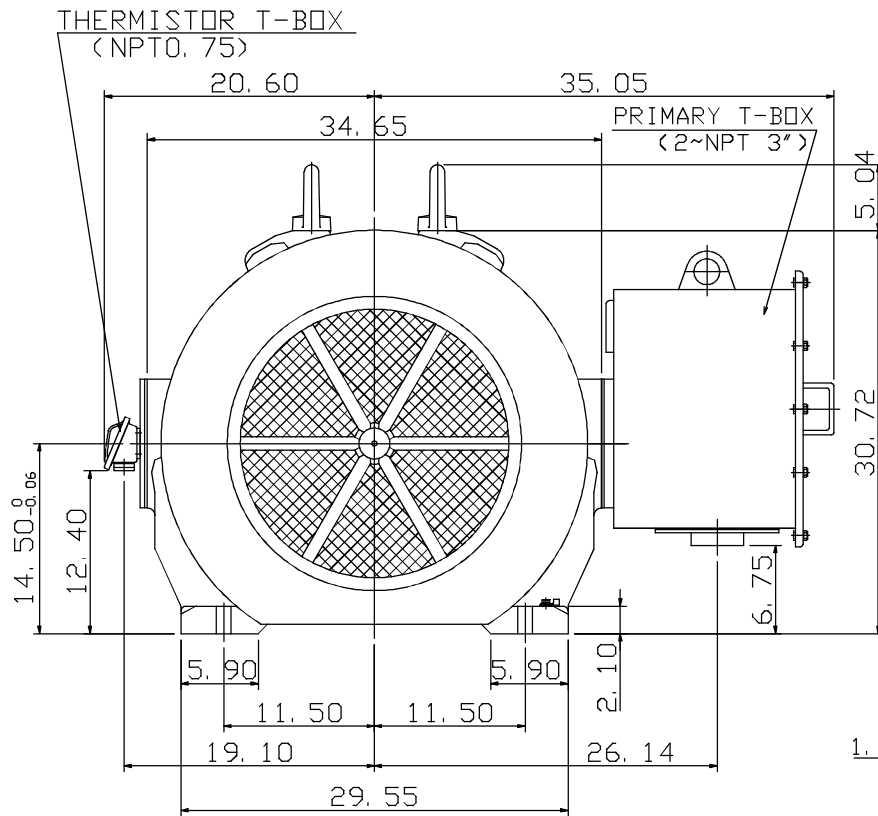

NOTE:

- DIMENSIONS IN INCHES
- FRAME NO. 5808C
- F CLASS INSULATION, S. F. 1.0 (50Hz)
F CLASS INSULATION, S. F. 1.15 (60Hz)
- FOR BELT SERVICE
- BEARING SIZE: DRIVE END: NU326C3
NON-DRIVE END: 6322C3
- ENCLOSURE: IP55
- WITH THERMISTOR: PTC 140°C 3PCS
- SHAFT MATERIAL: SCM440 Q&T (AISI 4140 EQUIV)
- MOTOR APPROX. WEIGHT: 6400 LBS

4A040Y700

| | | |
|-------|----------|-------------|
| DWN. | C. RAM | DEC 02 2015 |
| DWN. | H. CHANG | MAR 03 2015 |
| CHKD. | H. HUANG | MAR 03 2015 |
| APPD. | C. LIU | MAR 03 2015 |

CATALOG NO.
CD4008R

TEC Westinghouse

OUTLINE DIMENSIONS
3-PHASE INDUCTION MOTOR

DWG NO. REV: 00
4A040Y697