

Dimensional Drawing

Catalogue	Model	HP	Pole	kW	Rating	Voltage	Hz	RPM
SDP3504	ASHH	350	4	261	Continuous	460 V	60	1800

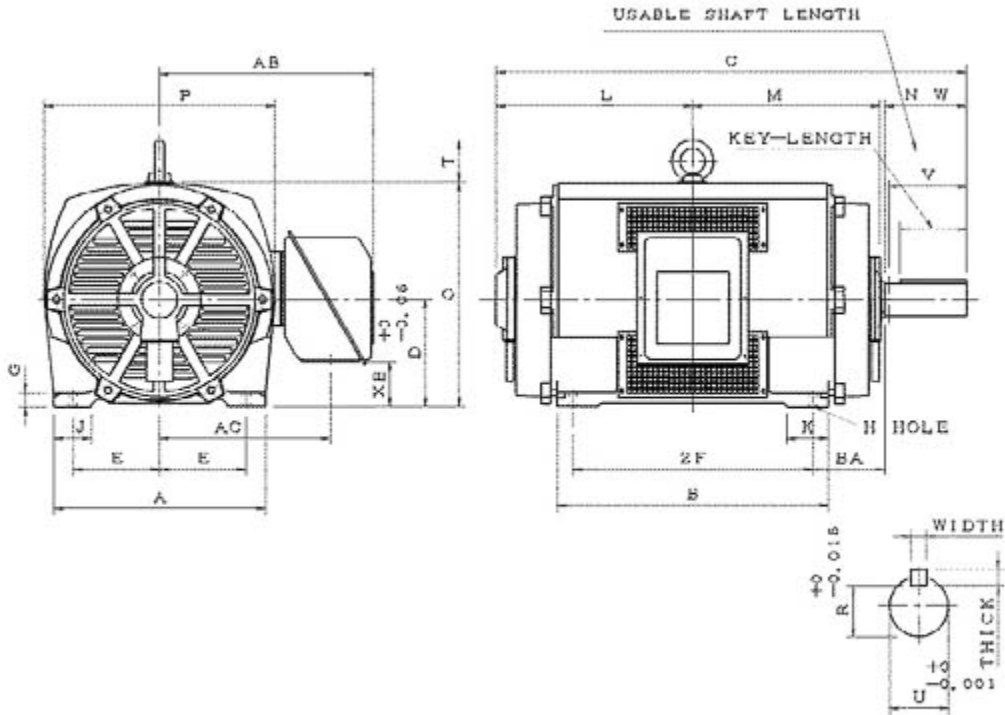

ASHH-HMP-1 1 0

Frame Size	Mounting					A	B	C	CD	D	
	E	2F	2F2	H	BA						
449T	9	25		0.81	7.5	22.05	27.95	48.95		11	
G	J	K	L	M	O	P	T	Key			Keyseat
1.4	3.95	4.35	20.45	19.85	23.15	24	4.35	Width	Thick	Length	R
								0.875	0.875	6.91	2.88
Terminal Housing				Aux Box		C/D Flange					
AA	AB	AC	XB	AE	AX	BB	AH	AK	BD	Aj	BF
	22.25	17.7	4.65								
Shaft Extension			Bearings		Approx. Weight Lbs	SPL dBA/3ft	Ins. Class	S.F.	Drive Method	Dimensions	
N-W	U	V	DE	NDE							
8.5	3.375	8	6320	6318	2310	85	F	1.15	Direct Coupling / Belt Drive	Inches	

Technical Data Sheet

Motor Type: ASHH

Catalogue No: SDP3504

Nameplate Information

HP	Pole	RPM	Frame	Voltage	Hz	Phase
350	4	1783	449T	460	60	3
Enclosure	Ins. Class	Service Factor	Time Rating	NEMA Design	Rated Amb.	Rated Altitude
ODP	F	1.15	Continuous	B	-40 to 40 °C	<3300 ft

Typical Performance

Efficiency (%)				Power Factor (%)		
Full Load		3/4 Load	1/2 Load	Full Load	3/4 Load	1/2 Load
Nom.	Min.					
95.8	95.0	95.5	94.6	87.5	84.0	81.0
Torque				Current (A)		
Full Load (lb-ft)	Locked Rotor (% FLT)	Pull Up (% FLT)	Break Down (% FLT)	No Load	Full Load	Locked Rotor
1031.00	120	100	230	107.5	391.0	2550
NEMA KVA Code	Inertia (WR ²)			Safe Stall Time (s)		Noise Level Sound Press. dB(A)
	Rotor (lb-ft ²)	NEMA Load (lb-ft ²)	Max. Allowable (lb-ft ²)	Cold	Hot	
G	77.500	-	1373	20	15	85

VFD Duty Information

Speed Range			VFD		S.F.
Constant Torque	Variable Torque	Constant Power	Carrier	Type	
20-60Hz	3-60Hz	60-120Hz	≤ 5 kHz	VPWM or CPWM	1.0 Only

Additional Information

Bearings		Approx. Weight
DE	NDE	lbs
6320	6318	2310

Hazardous Locations Information

N/A	
Temp Code (Sinewave / VFD)	/