

Dimensional Drawing

Catalogue	Model	HP	Pole	kW	Rating	Voltage	Hz	RPM
VCN0602	AMRCNH	60	2	45	Continuous	230 / 460 V	60	3600

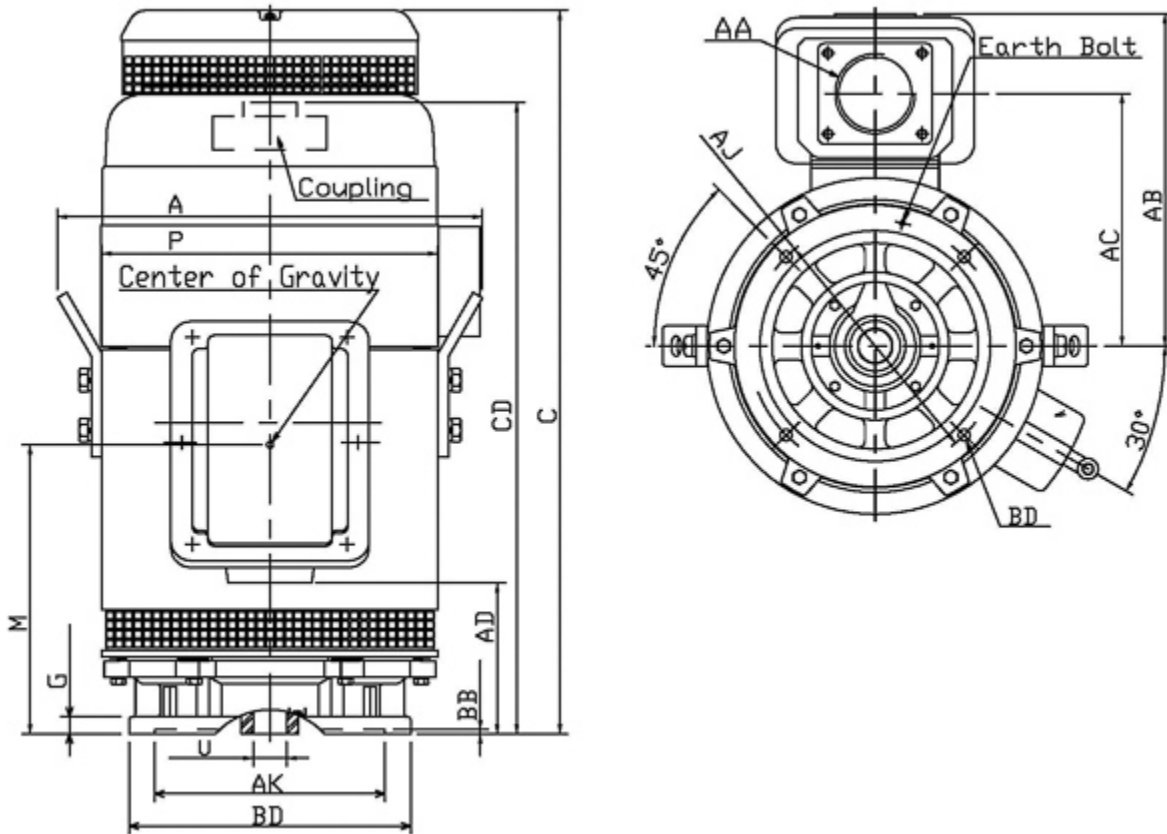

Frame Size	Mounting					A	B	C	CD	D	
	E	2F	2F2	H	BA						
326TP						20.87		32.71	28.22		
G	J	K	L	M	O	P	T	Key			Keyseat
						16.14		Width	Thick	Length	R
Terminal Housing				Aux Box		C/D Flange					
AA	AB	AC	XB	AE	AX	BB	AH	AK	BD	AJ	BF
3" NPT	14.72	11.3				0.28		13.5	16.5	14.75	0.69
Shaft Extension			Bearings		Approx. Weight Lbs	SPL dBA/3ft	Ins. Class	S.F.	Drive Method	Dimensions	
N-W	U	V	DE	NDE							
	1.653		6312C3	7220B	675		F	1.15	Direct Coupling	Inches	

Technical Data Sheet

Motor Type: AMRCNH

Catalogue No: VCN0602

Nameplate Information

HP	Pole	RPM	Frame	Voltage	Hz	Phase
60	2	3555	326TP	230 / 460	60	3
Enclosure	Ins. Class	Service Factor	Time Rating	NEMA Design	Rated Amb.	Rated Altitude
WPI	F	1.15	Continuous	B	-40 to 40 °C	<3300 ft

Typical Performance

Efficiency (%)				Power Factor (%)		
Full Load		3/4 Load	1/2 Load	Full Load	3/4 Load	1/2 Load
Nom.	Min.					
93.6	92.4	94.1	93.6	90.0	90.0	87.0
Torque				Current (A)		
Full Load (lb-ft)	Locked Rotor (% FLT)	Pull Up (% FLT)	Break Down (% FLT)	No Load	Full Load	Locked Rotor
88.61	190	160	260	30.4 / 15.2	133.4 / 66.7	870 / 435
NEMA KVA Code	Inertia (WR ²)			Safe Stall Time (s)		Noise Level Sound Press. dB(A)
	Rotor (lb-ft ²)	NEMA Load (lb-ft ²)	Max. Allowable (lb-ft ²)	Cold	Hot	
G	3.590	58	82	17	12	

VFD Duty Information

Speed Range			VFD		S.F.
Constant Torque	Variable Torque	Constant Power	Carrier	Type	
	7.5-60Hz:		≤ 3 kHz	VPWM or CPWM	1.0 Only

Additional Information

Bearings		Approx. Weight
DE	NDE	lbs
6312C3	7220B	675

Hazardous Locations Information

Temp Code (Sinewave / VFD)	/
----------------------------	---