

Dimensões em polegada
Dimensions in inches

THIS IS AN UPDATED REVISION, THE
PREVIOUS ONE MUST BE DISREGARDED.

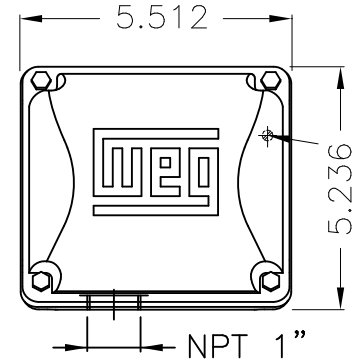
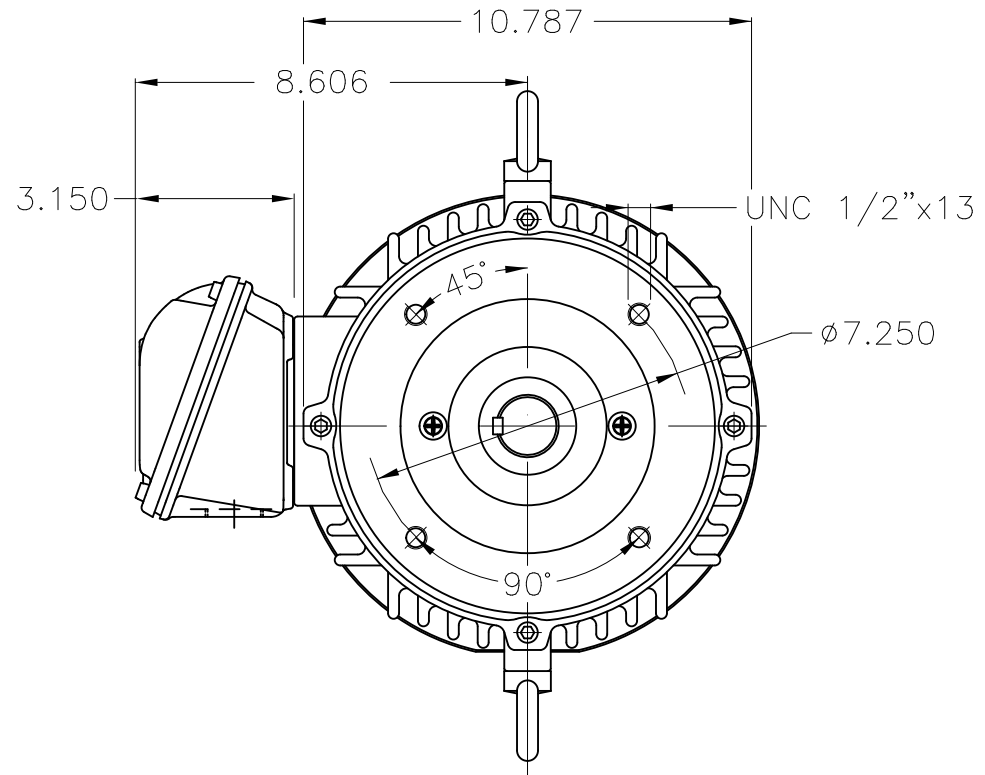

Grounding for leads 2-10 mm² / 14-7 AWG

Main terminal box

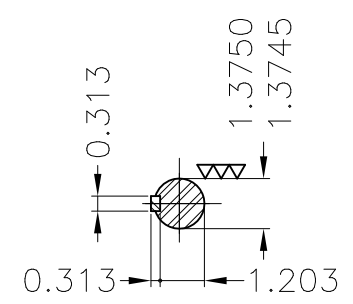
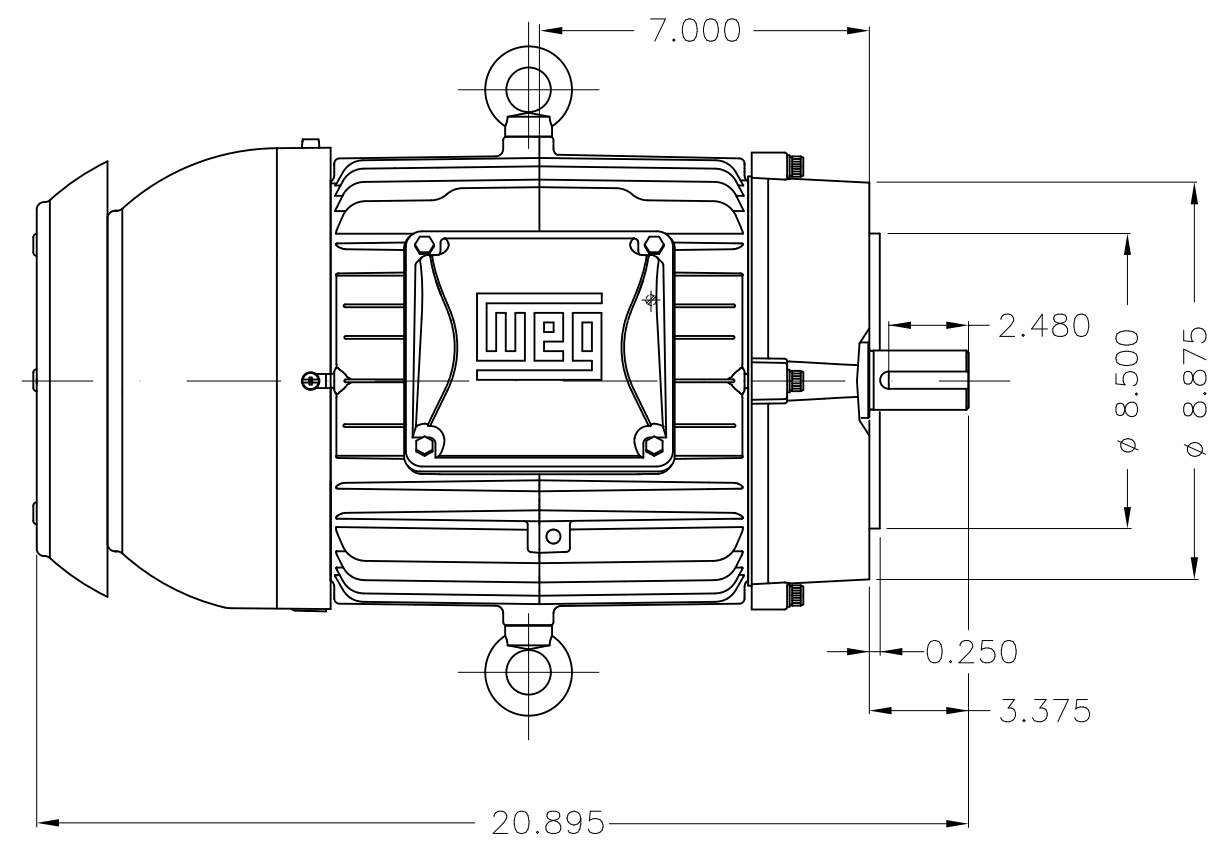

DE Shaft End

Bearing cap
Color RAL 5009
Painting plan 207A
Mounting V18

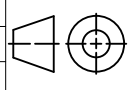
ECM	LOC	SUMMARY OF MODIFICATIONS			EXECUTED	CHECKED	RELEASED	DATE	VER
EXECUTED	USERADMIN	 THREE PHASE W22 MOTOR - NEMA PREMIUM EFF FRAME 215TC IP55 TEFC WEG code: 12821976							
CHECKED									
RELEASED									
REL DT	24.07.2017	WMO	Jaragua do Sul	Product Engineering	SHEET	1 / 1			

5 HP 06 Poles 60Hz

A

