

DATE
JUNE 27, 2011

OUTLINE DIMENSIONS

3-PHASE INDUCTION MOTOR

MOTOR TYPE:
AEHH8P-CF
FRAME NO. 364TC

CAT. #: NP0604C

Pole	HP	kW	Hz	VOLT	Syn.Speed r/min(rpm)
4	60	45	60	230/460	1800

Ins	Rating	Dimension in	Approx Weight	Bearings	
F	CONT.	inch	835 lbs.	DE: 6313	NDE: 6213

Totally Enclosed Fan-Cooled Type. Squirrel-Cage Rotor.

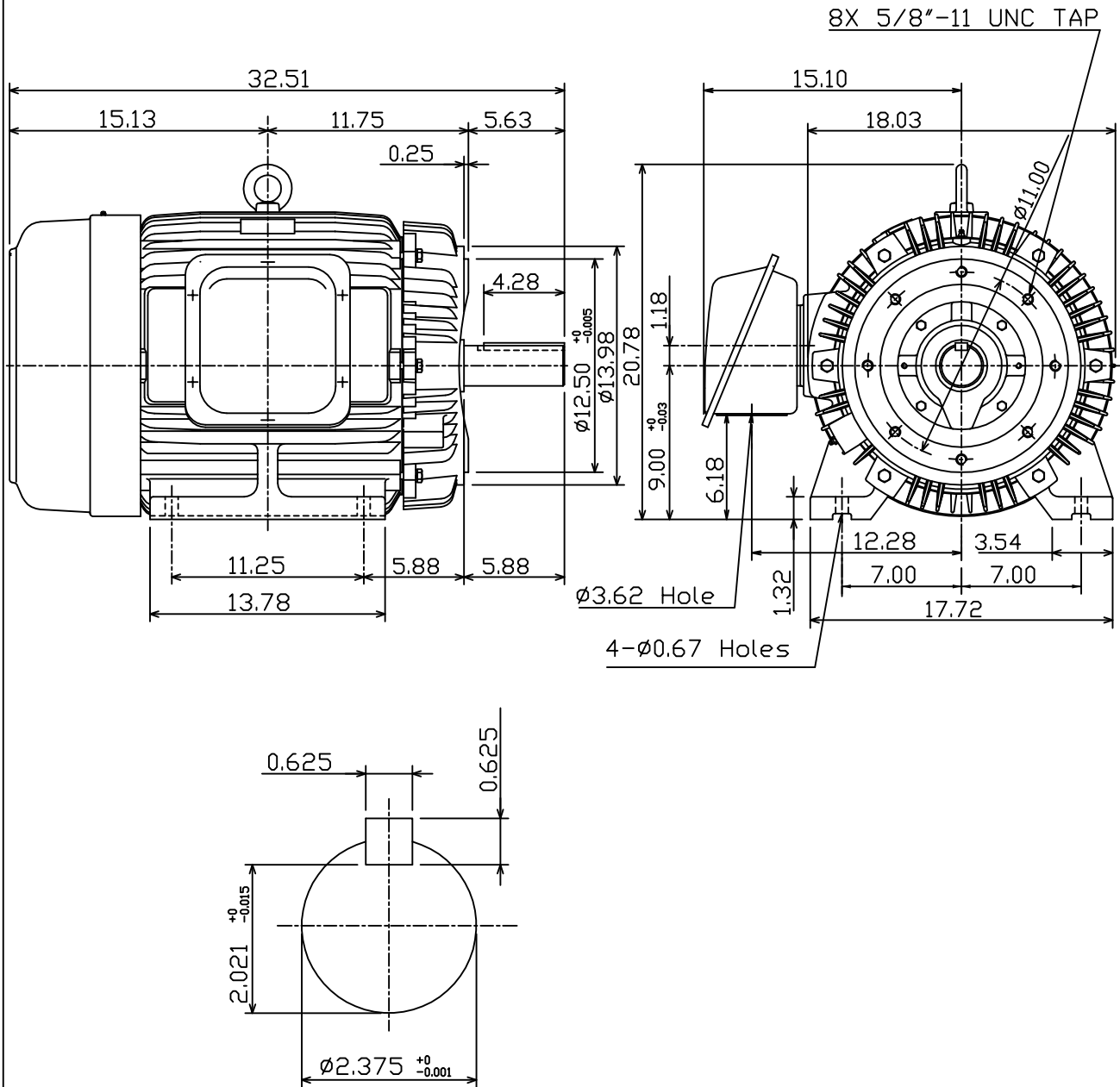

DWN.	K.L.KUD	04 -21 11
CHKD.	K.L.KUD	04 -21 11
APPD.	M.C.TSAI	04 -21 11

TECO Westinghouse

DWG NO.
31049M055170