

Dimensões em polegada  
Dimensions in inches

THIS IS AN UPDATED REVISION, THE  
PREVIOUS ONE MUST BE DISREGARDED.



Grounding for leads 25–50 mm<sup>2</sup> / 3–1 AWG

Main terminal box

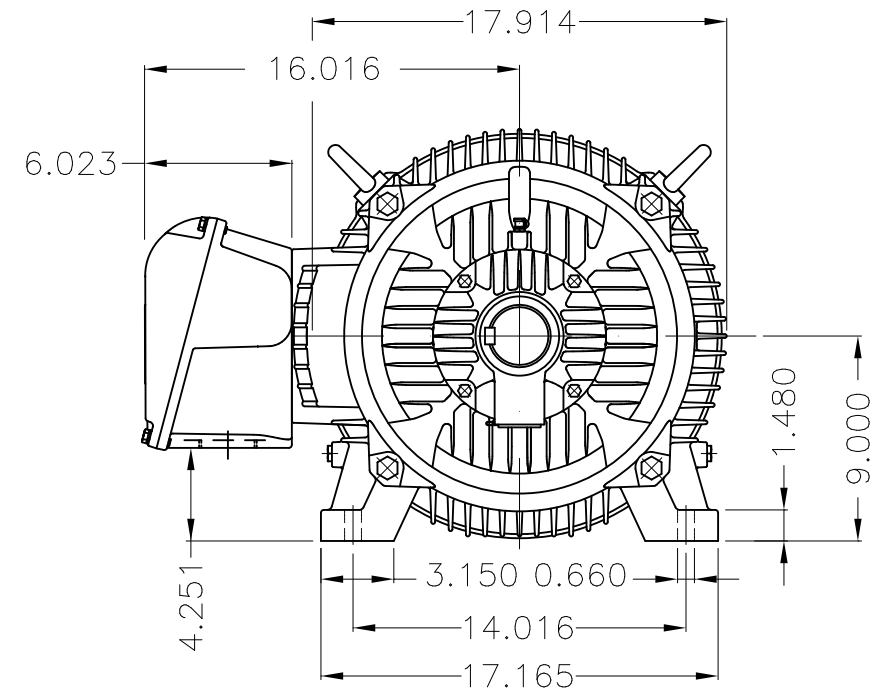

Grounding for leads 25–185 mm<sup>2</sup> / 3AWG–350MCM

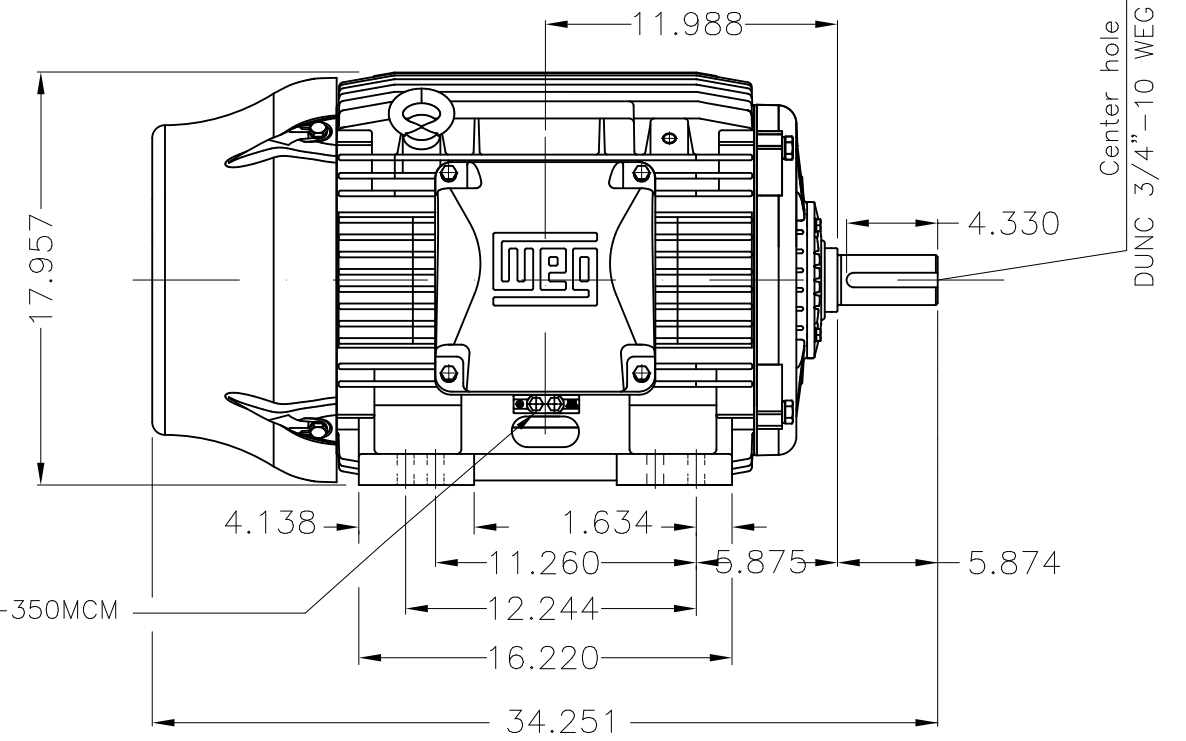

Center hole  
DUNC 3/4"–10 WEG TBG12

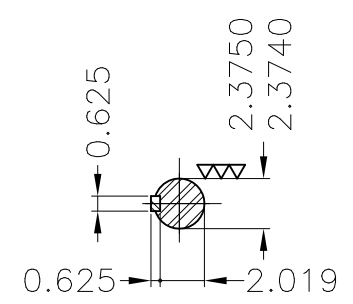

DE Shaft End

Color RAL 5009  
Painting plan 202E  
Mounting B3R(D)

ECM	LOC	SUMMARY OF MODIFICATIONS	EXECUTED	CHECKED	RELEASED	DATE	VER
EXECUTED	USERADMIN	THREE PH. W22 NEMA P.EFF MOTOR IEEE841					
CHECKED		FRAME 364/5T IP55 TEFC					
RELEASED		WEG code: 11431716					
REL DT	24.07.2017	WMO Jaragua do Sul	Product Engineering	SHEET	1 / 1		

30 HP 08 Poles 60Hz

A

